

## 1967 Firebird Full Brake Line Sets

	<u>1967 Brake Line Sets</u>	<u>Stainless</u>	<u>OE Steel</u>
PFB6701	1967 Manual Drum <b>1pc F to R</b> Brake Line Set 7pc	\$175.00	\$139.00
PFB6702	1967 Power Drum <b>1pc F to R</b> Brake Line Set 7pc	\$175.00	\$139.00
PFB6703	1967 Manual Disc <b>1pc F to R</b> Brake Line Set 8pc	\$175.00	\$139.00
PFB6704	1967 Power Disc <b>1pc F to R</b> Brake Line Set 8pc	\$170.00	\$139.00
PFB6705	1967 Manual Drum <b>2pc F to R</b> Brake Line Set 8pc	\$175.00	\$139.00
PFB6706	1967 Power Drum <b>2pc F to R</b> Brake Line Set 8pc	\$175.00	\$139.00
PFB6707	1967 Manual Disc <b>2pc F to R</b> Brake Line Set 9pc	\$175.00	\$139.00
PFB6708	1967 Power Disc <b>2pc F to R</b> Brake Line Set 9pc	\$170.00	\$139.00
PFB67F5	Disc Caliper Lines 2pc Set	\$25.00	\$20.00

## 1968 Firebird Full Brake Line Sets

	<u>1968 Brake Line Sets</u>	<u>Stainless</u>	<u>OE Steel</u>
PFB6801	1968 Manual Drum <b>1pc F to R</b> Brake Line Set 7pc	\$175.00	\$139.00
PFB6802	1968 Power Drum <b>1pc F to R</b> Brake Line Set 7pc	\$175.00	\$139.00
PFB6803	1968 Manual Disc <b>1pc F to R</b> Brake Line Set 8pc	\$175.00	\$139.00
PFB6804	1968 Power Disc <b>1pc F to R</b> Brake Line Set 8pc	\$170.00	\$139.00
PFB6805	1968 Manual Drum <b>2pc F to R</b> Brake Line Set 8pc	\$175.00	\$139.00
PFB6806	1968 Power Drum <b>2pc F to R</b> Brake Line Set 8pc	\$175.00	\$139.00
PFB6807	1968 Manual Disc <b>2pc F to R</b> Brake Line Set 9pc	\$175.00	\$139.00
PFB6808	1968 Power Disc <b>2pc F to R</b> Brake Line Set 9pc	\$170.00	\$139.00
PFB68F5	Disc Caliper Lines 2pc Set	\$25.00	\$20.00



**Inline Tube carries:**  
brake & fuel lines,  
parking brake cables,  
clips and clamps, rub-  
ber flex hoses, and any  
other under chassie  
part you will need.

## 1969 Firebird Full Brake Line Sets

	<u>1969 Brake Line Sets</u>	<u>Stainless</u>	<u>OE Steel</u>
PFB6901	1969 Manual Drum <b>1pc F to R</b> Brake Line Set 7pc	\$175.00	\$139.00
PFB6902	1969 Power Drum <b>1pc F to R</b> Brake Line Set 7pc	\$175.00	\$139.00
PFB6903	1969 Manual Disc <b>1pc F to R</b> Brake Line Set 8pc	\$175.00	\$139.00
PFB6904	1969 Power Disc <b>1pc F to R</b> Brake Line Set 8pc	\$170.00	\$139.00
PFB6905	1969 Manual Drum <b>2pc F to R</b> Brake Line Set 8pc	\$175.00	\$139.00
PFB6906	1969 Power Drum <b>2pc F to R</b> Brake Line Set 8pc	\$175.00	\$139.00
PFB6907	1969 Manual Disc <b>2pc F to R</b> Brake Line Set 9pc	\$175.00	\$139.00
PFB6908	1969 Power Disc <b>2pc F to R</b> Brake Line Set 9pc	\$170.00	\$139.00



## Disc Brake Conv. Line Sets

This brake line set is designed to convert Firebirds with drum to disc brakes. This kit mounts a prop valve to the right of the master using the bracket listed below. These are complete sets: Master cyl., Front, Inter, & Axle Lines.

PFB67D1	67 Power Disc Brake Line Set 8pc	\$165.00	\$139.00
PFB68D1	68 Power Disc Brake Line Set 8pc	\$165.00	\$139.00
PFB69D1	69 Power Disc Brake Line Set 8pc	\$165.00	\$139.00
BRK01	1967-69 Prop. Mounting Bracket	N/A	\$18.00
CFB67D3	1967-69 Prop Valve	N/A	\$85.00



**Inline Tube's disc  
brake conversions  
upgrade your drum  
brake car to discs  
using all factory  
components**



**Inline Tube Exclusive  
Ready to bolt on rear  
drum brakes for your  
concourse restoration.**



**Inline Tube has all the  
valves for your classic.  
Rebuilding is costly and  
only as good as the original  
part. Now you can buy new  
at a fraction of the cost.**

## 1967 Pontiac Firebird

Manual Drum Front Line Set

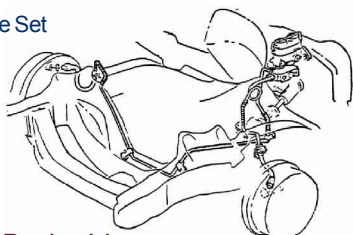

### Front Brake Lines

Stainless    OE Steel

PFB67F1	Manual Drum Brake Line Set 4pc	\$89.00	\$65.00
PFB67F2	Power Drum Brake Line Set 4pc	\$89.00	\$65.00
PFB67F3	Manual Disc Brake Line Set 5pc	\$89.00	\$65.00
PFB67F4	Power Disc Brake Line Set 5pc	\$89.00	\$65.00
PFB67F5	1967-68 Disc Caliper Lines 2pc (1/2-20 Lt Line, 7/16-24 Rt @caliper)	\$25.00	\$20.00
PFB67F6	1967-68 Disc Caliper Lines 2pc (3/8-24 Lt Line, 3/8-24 Rt @caliper)	\$25.00	\$20.00

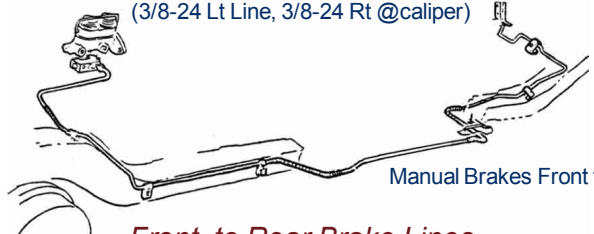

Manual Brakes Front to Rear

### Front to Rear Brake Lines

PFB67M1	Front to Rear Brake Line 1pc, Power Brakes	\$70.00	\$55.00
PFB67M2	Front to Rear Brake Line 2pc, Power Brakes	\$70.00	\$55.00
PFB67M3	Front to Rear Brake Line 1pc, Manual Brakes	\$70.00	\$55.00
PFB67M4	Front to Rear Brake Line 2pc, Manual Brakes	\$70.00	\$55.00

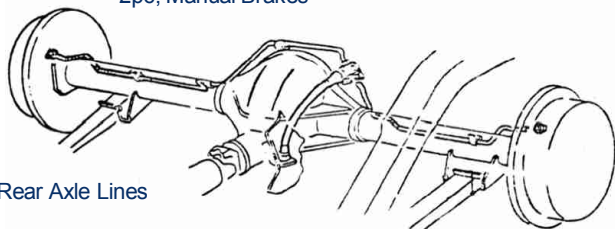

Rear Axle Lines

### Rear Axle Lines

PFB67R1	Mono Leaf Rear End 2pc	\$35.00	\$25.00
PFB67R2	Multi Leaf Rear End 2pc	\$35.00	\$25.00



**If you expect the highest quality parts, with the best service and the lowest price, Inline Tube can meet your expectations.**

When ordering **Stainless Steel Lines** Please place a "S" in front of the part number.



## 1967 Pontiac Firebird

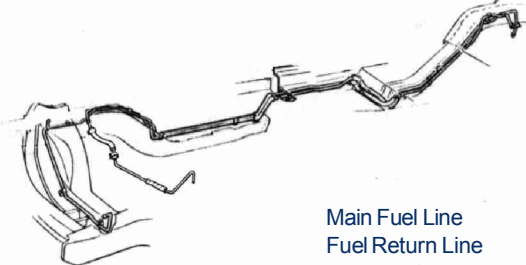

Main Fuel Line  
Fuel Return Line

### Main Fuel Lines

Stainless    OE Steel

PFF6701	Main Fuel Line Tank to Pump 2pc, 3/8" Pass Side Routing	\$99.00	\$65.00
PFF6703	Fuel Return Line Tank to Pump	\$99.00	\$65.00

### Transmission Lines

PFT6701	Transmission Cooler Lines Turbo 350, 2pc, 5/16"	\$75.00	\$45.00
PFT6702	Transmission Cooler Lines Turbo 400, 2pc, 5/16"	\$75.00	\$45.00
PFT6703	Transmission Cooler Lines Power Glide, 2pc, 5/16"	\$75.00	\$45.00

### Transmission Modulator Line

PFT6704	Turbo 400 V8 4bbl	\$35.00	\$25.00
PFT6705	Powerglide V8 4bbl	\$35.00	\$25.00
PFT6706	Turbo 400 V8 2bbl	\$35.00	\$25.00
PFT6707	Powerglide V8 2bbl	\$35.00	\$25.00

### Engine Lines

PFE6701	1967 4bbl 400 cid Carb Line, 1pc	\$25.00	\$18.00
PFE6702	1967 2bbl 400 cid Carb Line, 1pc	\$25.00	\$18.00
PFE6703	1967 4bbl 326 cid Carb Line, 1pc Carter Carb	\$25.00	\$18.00
PFE6803	1967-68 Power Steering Return Line 1pc	\$18.00	\$14.00

### Rubber Flex Hoses

OEM

PH-579	1967-68 Front Disc Hose	\$24.00 ea
PH-525	1967-69 Front Drum Hose	\$24.00 ea
PH-586	1967-69 Rear Hose	\$25.00 ea



### Rubber Fuel Lines

FHS-301	3/8" (2') hose with 4 correct color clips Used for both ends of Main Fuel Line	\$4.50
FHS-302	5/16" (2') hose with 4 correct color clips Used for Main Fuel Line or Vapor Line	\$4.50
FHS-303	1/4" (2') hose with 4 correct color clips Used for Fuel Return Line	\$4.50



**Inline Tube carries hundreds of hoses and now we have made all the frame brackets for the popular cars.**

## 1968 Pontiac Firebird

Manual Drum Front Line Set

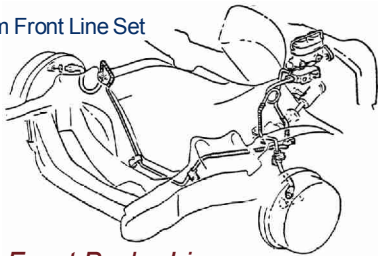

### Front Brake Lines

		<u>Stainless</u>	<u>OE Steel</u>
PFB68F1	Manual Drum Brake Line Set 4pc	\$89.00	\$65.00
PFB68F2	Power Drum Brake Line Set 4pc	\$89.00	\$65.00
PFB68F3	Manual Disc Brake Line Set 5pc	\$89.00	\$65.00
PFB68F4	Power Disc Brake Line Set 5pc	\$89.00	\$65.00
PFB68F5	1967-68 Disc Caliper Lines 2pc (1/2-20 Lt Line, 7/16-24 Rt @caliper)	\$25.00	\$18.00
PFB68F6	1967-68 Disc Caliper Lines 2pc (3/8-24 Lt Line, 3/8-24 Rt @caliper)	\$25.00	\$18.00

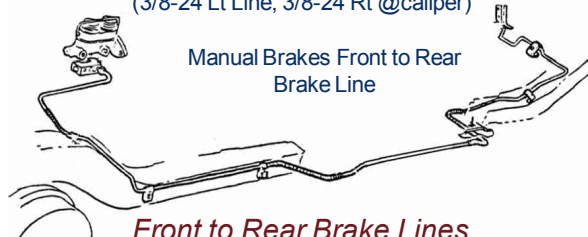

Manual Brakes Front to Rear  
Brake Line

### Front to Rear Brake Lines

PFB68M1	Front to Rear Brake Line 1pc, Power Brakes	\$70.00	\$55.00
PFB68M2	Front to Rear Brake Line 2pc, Power Brakes	\$70.00	\$55.00
PFB68M3	Front to Rear Brake Line 1pc, Manual Brakes	\$70.00	\$55.00
PFB68M4	Front to Rear Brake Line 2pc, Manual Brakes	\$70.00	\$55.00

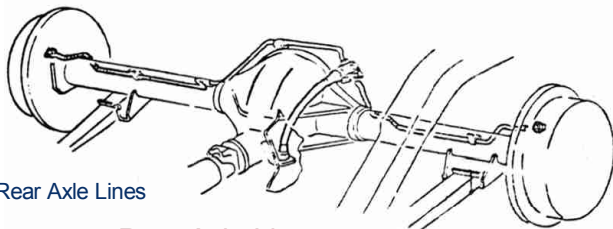

Rear Axle Lines

### Rear Axle Lines

PFB68R1	Mono Leaf Rear End 2pc	\$35.00	\$25.00
PFB68R2	Multi Leaf Rear End 2pc	\$35.00	\$25.00



**Not ready to do the full disc brake conversion? All parts are available separate to fit any budget.**



**Inline Tube Exclusive Ready to bolt on rear drum brakes for your concours restoration.**

## 1968 Pontiac Firebird

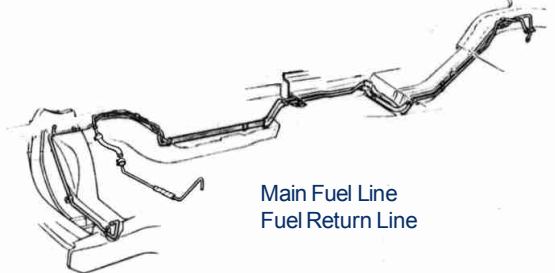

Main Fuel Line  
Fuel Return Line

### Main Fuel Lines

		<u>Stainless</u>	<u>OE Steel</u>
PFF6801	Main Fuel Line Tank to Pump 2pc, 3/8" Pass Side Routing	\$99.00	\$65.00
PFF6803	Fuel Return Line Tank to Pump 1/4"	\$99.00	\$65.00

### Transmission Lines

PFT6801	Transmission Cooler Lines Turbo 350, 2pc, 5/16"	\$75.00	\$45.00
PFT6802	Transmission Cooler Lines Turbo 400, 2pc, 5/16"	\$75.00	\$45.00
PFT6803	Transmission Cooler Lines Power Glide, 2pc, 5/16"	\$75.00	\$45.00

### Transmission Modulator Line

PFT6804	Turbo 400 V8 4bbl	\$35.00	\$25.00
PFT6805	Powerglide V8 4bbl	\$35.00	\$25.00
PFT6806	Turbo 400 V8 2bbl	\$35.00	\$25.00
PFT6807	Powerglide V8 2bbl	\$35.00	\$25.00

### Engine Lines

PFE6801	1968 2bbl V8 Carb Line, 1pc	\$25.00	\$18.00
PFE6802	1968 4bbl V8 Carb Line, 1pc	\$25.00	\$18.00
PFE6803	67-68 Power Steering Return Line	\$18.00	\$14.00

### Rubber Flex Hoses

		<u>OEM</u>
H-579	1967-68 Front Disc Hose	\$24.00 ea
H-525	1967-69 Front Drum Hose	\$24.00 ea
H-586	1967-69 Rear Hose	\$25.00 ea



**Long after restoration is done, the Inline Tube quality and name will be remembered. Make the Inline Tube choice.**



**Inline Tube carries all the brake parts to restore your classic. Why rebuild that old booster when you can buy a show quality booster for less.**



**Clip Sets Available for Most Cars Page 229**

## 1969 Pontiac Firebird/TA

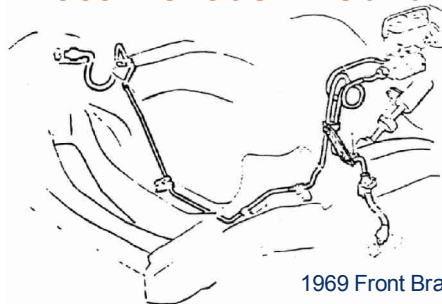

1969 Front Brake Line Set

### Front Brake Line Sets

		Stainless	OE Steel
PFB69F1	Manual Drum Brake Line Set 4pc	\$89.00	\$65.00
PFB69F2	Power Drum Brake Line Set 4pc	\$89.00	\$65.00
PFB69F3	Manual Disc Brake Line Set 5pc	\$89.00	\$65.00
PFB69F4	Power Disc Brake Line Set 5pc	\$89.00	\$65.00

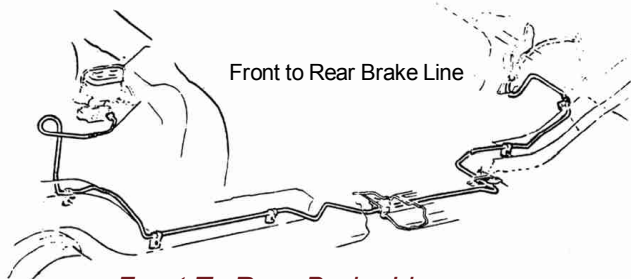

Front to Rear Brake Line

### Front To Rear Brake Lines

PFB69M1	Front To Rear Brake Line 1pc Power Brakes	\$70.00	\$55.00
PFB69M2	Front To Rear Brake Line 2pc Power Brakes	\$70.00	\$55.00
PFB69M3	Front To Rear Brake Line 1pc Manual Brakes	\$70.00	\$55.00
PFB69M4	Front To Rear Brake Line 2pc Manual Brakes	\$70.00	\$55.00

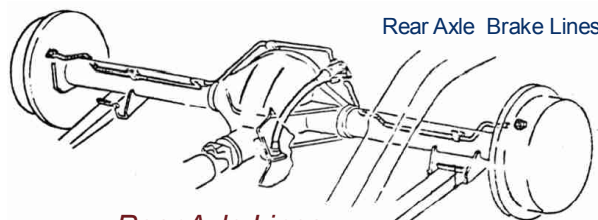

Rear Axle Brake Lines

### Rear Axle Lines

PFB69R1	Axle Lines 2pc Firebird Only	\$35.00	\$25.00
PFB69R2	Axle Lines 2pc TA Only	\$35.00	\$25.00
PFB69R3	Axle Lines 2pc TA / Firebird	\$35.00	\$25.00

Van Nuys California Assembly Plant



### Rubber Flex Hoses

		OEM
PH-672	1969-70 Front Disc Hose	\$25.00 ea
PH-525	1967-69 Front Drum Hose	\$24.00 ea
PH-586	1967-69 Rear Hose	\$25.00 ea

## 1969 Pontiac Firebird/TA

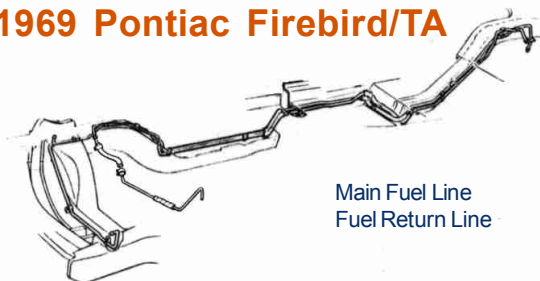

Main Fuel Line  
Fuel Return Line

### Main Fuel Lines

		Stainless	OE Steel
PFF6901	Main Fuel Line Tank to Pump 1pc, 3/8" Pass Side Routing	\$99.00	\$65.00
PFF6903	Fuel Return Line Tank to Pump	\$99.00	\$65.00

### Transmission Lines

PFT6901	Transmission Cooler Lines Turbo 350, 2pc, 5/16"	\$75.00	\$45.00
PFT6902	Transmission Cooler Lines Turbo 400, 2pc, 5/16"	\$75.00	\$45.00

### Transmission Modulator Lines

PFT6903	Transmission Modulator Line Turbo 400, 1pc, 2bbl	\$35.00	\$25.00
PFT6904	Transmission Modulator Line Turbo 350, 1pc, 2bbl	\$35.00	\$25.00
PFT6905	Transmission Modulator Line Turbo 400, 1pc, 4bbl	\$35.00	\$25.00
PFT6906	Transmission Modulator Line Turbo 350, 1pc, 4bbl	\$35.00	\$25.00

### Engine Lines

PFE6901	1969 2bbl V8, PS Bottom Outlet Pump, Pass Side of Thermostat Housing	\$25.00	\$18.00
PFE6909	1969 2bbl V8, DS Bottom Outlet Pump, Driver Side of Thermostat Housing	\$25.00	\$18.00
PFE6902	1969 all 4bbl V8 & Ram Air III Bottom Outlet Pump, Pass Side of Thermostat Housing	\$25.00	\$18.00
PFE6903	1969 4bbl V8, Ram Air IV only Bottom Outlet Pump, Driver Side of Thermostat Housing	\$25.00	\$18.00
PFE6904	Pump to Carb 6cyl OHC	\$25.00	\$18.00
PFE6905	Power Steering Cooler Line	\$35.00	\$25.00
PFE6906	Carb Vacuum Line V8, 4bbl, AT	\$12.00	\$10.00
PFE6910	Carb Vacuum Line V8, 2bbl, AT	\$12.00	\$10.00
PFE6908	Vac. Advance Line V8, 4bbl, MT	\$16.00	\$12.00
PFE6907	Power Steering Return Line	\$12.00	\$10.00



**Inline Tube does not install the parts, we manufacture only the highest quality parts on the market so the installation is a snap.**



**Inline Tube's disc brake conversions upgrade your drum brake car to disc using all factory components.**

## 1970 Pontiac Firebird/TA

### Full Brake Line Sets

		<u>Stainless</u>	<u>OE Steel</u>
PFB7001	Power Disc Brake Line Set 1970 only, 10pc Set	\$185.00	\$155.00
PFB7002	Manual Disc Brake Line Set 1970 only, 10pc Set	\$185.00	\$155.00

### Rubber Flex Hoses

		<u>OEM</u>
H-672	1969-70 Front Disc Hose	\$25.00ea

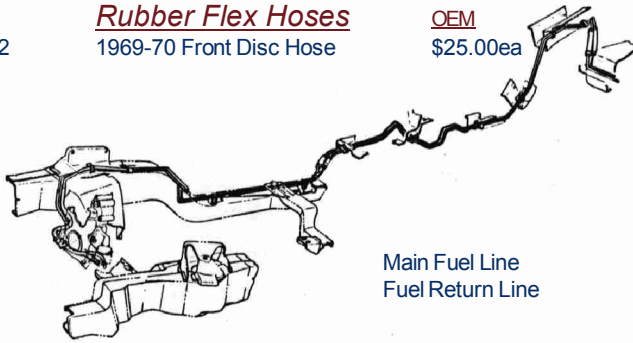

### Main Fuel Lines

PFF7001	1970-71 Fuel Line Tank to Pump 2pc, 3/8" Pass Side Routing	\$99.00	\$69.00
PFF7003	1970-71 Fuel Return Line Tank to Pump 1/4" PS Routing	\$99.00	\$69.00

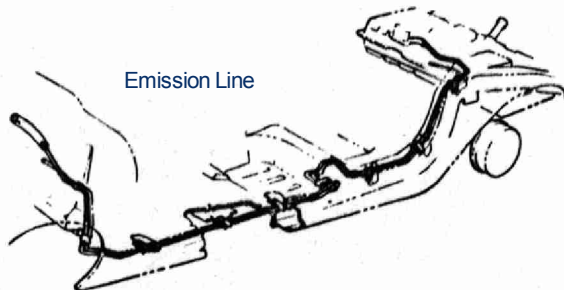

### Fuel Emission Lines

PFF7004	1970 Main Vapor Line 1pc DS Routing, Calif Cars Only	\$99.00	\$69.00
---------	---	---------	---------

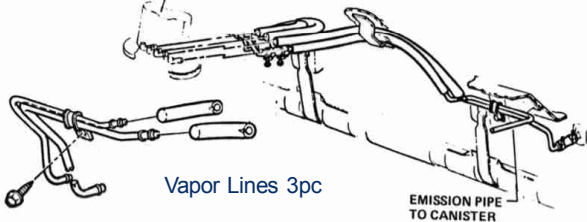

PFF7005	1970 Vapor Lines 3pc, Calif Only	\$39.00	\$29.00
---------	----------------------------------	---------	---------

### Transmission Lines

PFT7001	1970-72 Trans Cooler Lines Turbo 350, 2pc, 5/16"	\$75.00	\$45.00
PFT7002	1970-72 Trans Cooler Lines Turbo 400, 2pc, 5/16"	\$75.00	\$50.00
PFT7003	1970-72 Trans Mod Line T-400	\$35.00	\$25.00
PFT7004	1970-72 Trans Mod Line T-350	\$35.00	\$25.00

## 1970 Pontiac Firebird/TA

### Engine Lines

		<u>Stainless</u>	<u>OE Steel</u>
PFE7001	1970 2bbl V8	\$25.00	\$18.00
PFE7002	1970 4bbl V8, all & Ram Air III Bottom Outlet Pump Passes Passenger Side of Thermostat Housing	\$25.00	\$18.00
PFE7003	1970 4bbl V8, Ram Air IV Bottom Outlet Pump Passes Driver Side of Thermostat Housing	\$25.00	\$18.00

## 1971 Pontiac Firebird/TA

### 71-73 Full Brake Line Set

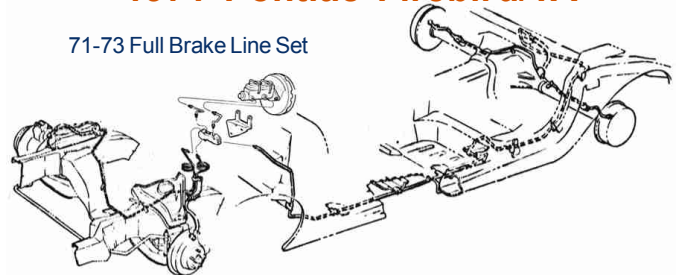

### Full Brake Line Sets

		<u>Stainless</u>	<u>OE Steel</u>
PFB7101	Power Disc Brake Line Set 1971-73, 7pc Set	\$175.00	\$145.00
PFB7102	Manual Disc Brake Line Set 1971-73, 7pc Set	\$175.00	\$145.00

### Main Fuel Lines

PFF7101	1970-71 Fuel Line Tank to Pump 2pc, 3/8" Pass Side Routing	\$99.00	\$69.00
PFF7103	1970-71 Fuel Return Line Tank to Pump 1/4" PS Routing	\$99.00	\$69.00

### Fuel Emission Lines

PFF7106	1971-74 Vapor Line 1pc Core Support, 5/16" dia	\$35.00	\$25.00
PFF7104	1971-73 Main Vapor Line 1pc DS Routing	\$99.00	\$69.00
PFF7105	1971-73 Vapor Tank Lines 3pc	\$39.00	\$29.00

### Transmission Lines

PFT7101	1971 Trans Cooler Lines 2pc, Turbo 350 / 400, 5/16" - with 5/8-18 Red Fittings @ Rad	\$75.00	\$45.00
PFT7102	1970-72 Trans Cooler Lines 2pc Turbo 350/400, 5/16" - with 1/2-20 Std. Fitting @ Rad	\$75.00	\$45.00
PFT7103	1970-72 Trans Mod Line T-400	\$35.00	\$25.00
PFT7104	1970-72 Trans Mod Line T-350	\$35.00	\$25.00

### Engine Lines

PFE7101	1971 4bbl 455 cid Pump to Carb	\$25.00	\$20.00
PFE7102	1971 4bbl 400 cid Pump to Carb	\$25.00	\$20.00

## Quick Tip: Fluid

DOT 3 originally came in the brake system. This fluid can destroy your paint and collects moisture which over time reduces performance. Under extreme braking conditions (constant drag racing) or excessive braking, Dot 3 will out perform DOT 5 (silicone fluid). DOT 5 is an excellent choice for museum cars since it will not collect moisture and does not harm paint. Never mix DOT 5 & DOT 3 fluids.



Clip Sets are Available for  
Pontiac Cars Pg 229

## 1972-73 Pontiac Firebird/TA

71-73 Full Brake Line Set

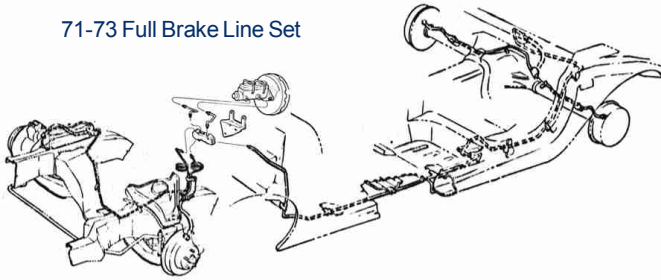

### Full Brake Line Sets

		<u>Stainless</u>	<u>OE Steel</u>
PFB7201	Power Disc Brake Line Set 1971-73, 7pc Set	\$175.00	\$145.00
PFB7202	Manual Disc Brake Line Set 1971-73, 7pc Set	\$175.00	\$145.00

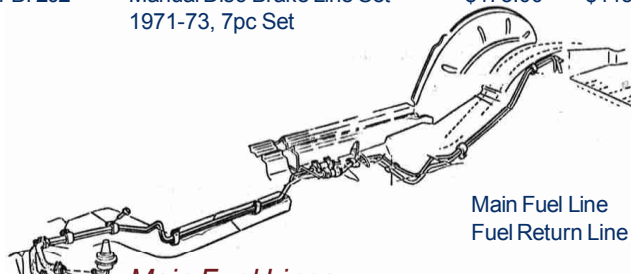

Main Fuel Line  
Fuel Return Line

### Main Fuel Lines

PFF7201	1972-74 Fuel Line Tank to Pump 2pc, 3/8" Pass Side Routing	\$99.00	\$69.00
PFF7203	1972-74 Fuel Return Line Tank to Pump 1/4" PS Routing	\$99.00	\$69.00

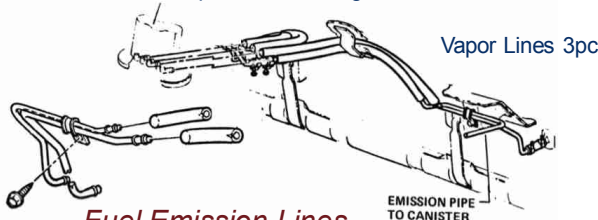

Vapor Lines 3pc

### Fuel Emission Lines

PFF7206	1972-74 Vapor Line 1pc Core Support, 5/16" dia	\$35.00	\$25.00
PFF7204	1972-73 Main Vapor Line 1pc DS Routing	\$99.00	\$69.00
PFF7205	1971-73 Vapor Lines 3pc	\$39.00	\$29.00

### Transmission Lines

PFT7201	1970-72 Trans Cooler Lines Turbo 350, 2pc, 5/16"	\$75.00	\$45.00
PFT7202	1970-72 Trans Cooler Lines Turbo 400, 2pc, 5/16"	\$75.00	\$45.00
PFT7301	1973 Trans Cooler Lines Turbo 400/350, 2pc, 5/16"	\$75.00	\$45.00
PFT7203	1972-73 Trans Mod Line T-400	\$35.00	\$25.00
PFT7204	1972-73 Trans Mod Line T-350	\$35.00	\$25.00

### Engine Lines

PFE7201	1972 Pump to Carb 400/455 4bbl	\$25.00	\$20.00
PFE7301	1973-74 Pump to Carb 400 4bbl	\$25.00	\$20.00
PFE7302	1973-74 Pump to Carb 455 4bbl	\$25.00	\$20.00
PFE7302	1973-74 Pump to Carb 455 4bbl SD with Foam Rubber	\$33.00	\$28.00

## 1974 Pontiac Firebird/TA

74-75 Full Brake Line Set

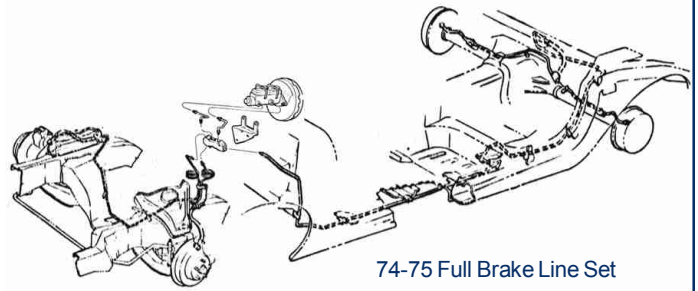

### Full Brake Line Sets

		<u>Stainless</u>	<u>OE Steel</u>
PFB7401	Power Disc Brake Line Set 1974-75, 7pc Set	\$175.00	\$145.00
PFB7402	Manual Disc Brake Line Set 1974-75, 7pc Set	\$175.00	\$145.00

## Photo Opposite Side of Page

### Main Fuel Lines

PFF7401	1972-74 Fuel Line Tank to Pump 2pc, 3/8" Pass Side Routing	\$99.00	\$69.00
PFF7403	1972-74 Fuel Return Line Tank to Pump 1/4" PS Routing	\$99.00	\$69.00

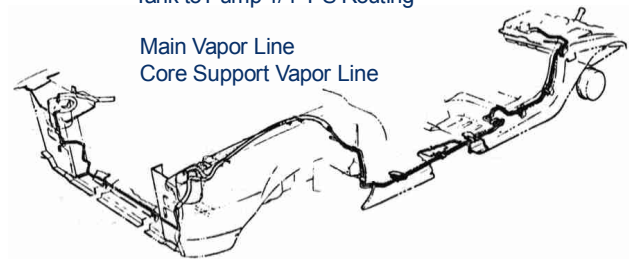

Main Vapor Line  
Core Support Vapor Line

### Fuel Emission Lines

PFF7406	1972-74 Vapor Line 1pc Core Support, 5/16" dia	\$35.00	\$25.00
PFF7404	1974 Main Vapor Line 1pc DS Routing	\$99.00	\$69.00

### Transmission Lines

PFT7401	1974-75 Trans Cooler Lines Turbo 350, 2pc, 5/16"	\$75.00	\$45.00
PFT7402	1974-75 Trans Cooler Lines Turbo 400, 2pc, 5/16"	\$75.00	\$45.00
PFT7403	1974-75 Trans Mod Line T-400	\$35.00	\$25.00
PFT7404	1974-75 Trans Mod Line T-350	\$35.00	\$25.00

### Engine Lines

PFE7301	1973-74 Pump to Carb 400 4bbl	\$25.00	\$20.00
PFE7302	1973-74 Pump to Carb 455 4bbl	\$25.00	\$20.00
PFE7302	1973-74 Pump to Carb 455 4bbl SD with Foam Rubber	\$33.00	\$28.00



**Our attention to detail has made us the best in the industry. Our restoration projects allow us to pass our technical knowledge on to you.**

## 1975 Pontiac Formula /TA

### Full Brake Line Sets

		<u>Stainless</u>	<u>OE Steel</u>
PFB7501	Power Disc Brake Line Set 1974-75, 7pc Set	\$175.00	\$145.00
PFB7502	Manual Disc Brake Line Set 1974-75, 7pc Set	\$175.00	\$145.00

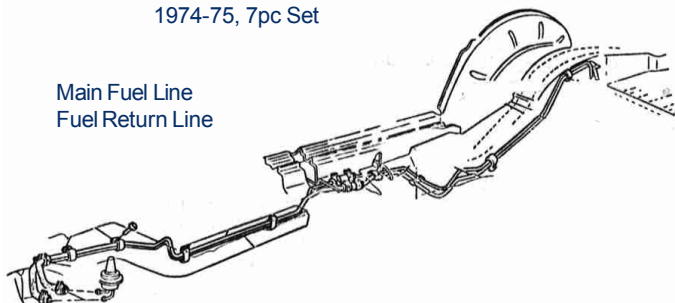

### Main Fuel Lines

PFF7501	1975-79 Fuel Line Tank to Pump 2pc, 3/8" Driver Side Routing	\$99.00	\$69.00
PFF7502	1975-79 Fuel Return Line Tank to Pump 1/4" PS Routing	\$99.00	\$69.00

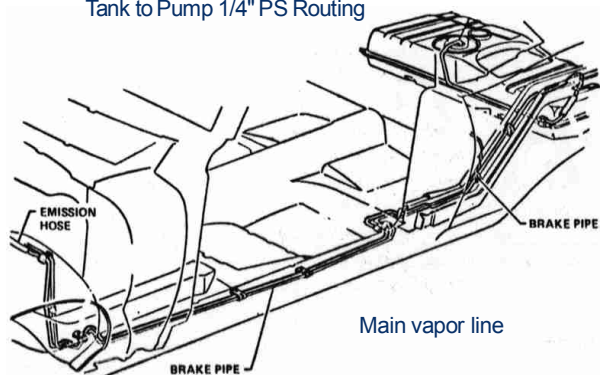

### Fuel Emission Lines

PFF7503	1975-79 Vapor Lines 2pc Passenger Side Routing	\$99.00	\$69.00
---------	---	---------	---------

### Transmission Lines

PFT7501	1974-75 Trans Cooler Lines Turbo 350, 2pc, 5/16"	\$75.00	\$45.00
PFT7502	1974-75 Trans Cooler Lines Turbo 400, 2pc, 5/16"	\$75.00	\$45.00
PFT7503	1975-79 Trans Modulator Line Pontiac 400	\$35.00	\$25.00

### Engine Lines

PFE7501	1975 Pump to Carb 400 4bbl	\$25.00	\$20.00
PFE7502	1975 Pump to Carb 455 4bbl	\$25.00	\$20.00
PFE7503	1975 Pump to Carb 350 4bbl	\$25.00	\$20.00



**Stainless Brake Cables Page 190**

When ordering **Stainless Steel Lines**  
Please place a "S" in front of the part number.

## 1976-79 Pontiac Formula /TA

### 76-79 Full Brake Line Set

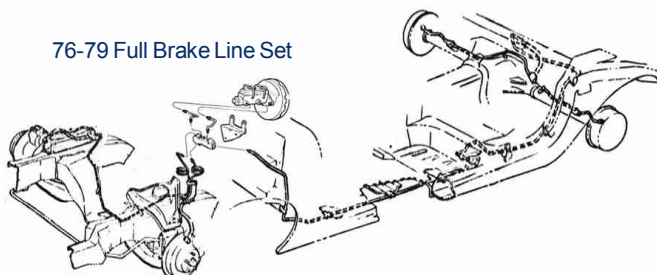

### Full Brake Line Sets

		<u>Stainless</u>	<u>OE Steel</u>
PFB7601	Power Disc Brake Line Set 1976-80, 7pc Set	\$175.00	\$145.00
PFB7602	4 Wheel Disc Brake Line Set 1979-80, 7pc Set	\$175.00	\$145.00

### Main Fuel Lines

PFF7601	1975-79 Fuel Line Tank to Pump 2pc, 3/8", 403 Olds cid, DS Routing, PS Fuel Pump	\$99.00	\$69.00
PFF7603	1975-79 Fuel Line Tank to Pump 2pc, 3/8", Pont V8, 400 cid, DS Routing, DS Fuel Pump	\$99.00	\$69.00
PFF7606	1975-79 Fuel Return Line, 2pc, 1/4"	\$99.00	\$69.00
PFF7607	Tank to Pump, 403 Olds cid, PS Routing, PS Fuel Pump 1975-79 Fuel Return Line, 2 pc 1/4" \$99.00	\$99.00	\$69.00
	Tank to Pump, Pont V8, 400 cid, PS Rout, DS Fuel Pump		

### Fuel Emission Lines

PFF7604	1975-79 Vapor Lines 2pc 403 Olds cid, PS Routing	\$99.00	\$69.00
PFF7608	1975-79 Vapor Lines 2pc Pont V8, 400 cid, PS Routing	\$99.00	\$69.00
PFF7701	1977-78 Vapor Tank Lines 3pc Trans Am	\$95.00	\$85.00

### Transmission Lines

PFT7601	1976-81 Trans Cooler Lines Turbo 350, 2pc, 5/16"	\$75.00	\$45.00
PFT7602	1976-81 Trans Cooler Lines Turbo 400, 2pc, 5/16"	\$75.00	\$45.00
PFT7603	1975-78 Trans Modulator Line Pontiac 400	\$35.00	\$25.00
PFT7604	1979-81 Trans Modulator Line Oldsmobile 403	\$35.00	\$25.00

### Engine Lines

PFE7601	1976 Pump to Carb 4bbl 400	\$33.00	\$28.00
PFE7702	1977-79 Pump to Carb 4bbl 400 With Black Insulation	\$33.00	\$28.00
PFE7701	1977-78 Booster Vacuum Line Pontiac 400 Eng	\$14.00	\$12.00
PFE7703	1977-78 Carb to Vacuum Canister Pont Eng 4bbl 400	\$25.00	\$20.00
PFE7704	1979 Carb to Exhaust Manifold Pont Eng 4bbl 400	\$16.00	\$12.00

### Engine Lines - Olds 403 cid 4bbl

PFE7902	1977-79 Pump to Carb 4bbl 403	\$25.00	\$20.00
PFE7903	1977-79 Choke Tubes 4bbl 403	\$24.00	\$20.00
PFE7901	1978-79 Booster Vac Line 403	\$14.00	\$12.00
PFE7905	1977 Booster Vac Line 403	\$14.00	\$12.00
PFE7904	1977-79 Oil Press Line 4bbl 403	\$11.00	\$9.00

State: Pontiac or Olds Engine & Long Fuel Pump or Short Fuel Pump

## 1980-81 Pontiac Firebird/TA

80-81 Full Brake Line Set

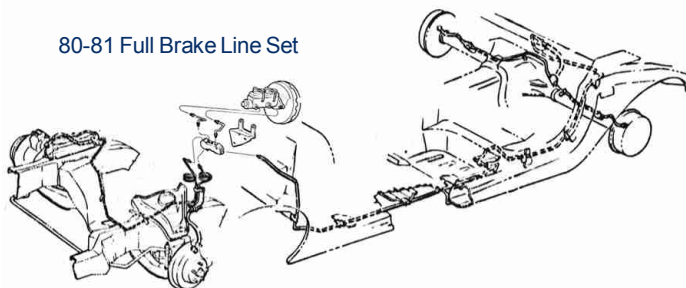

	<u>Full Brake Line Sets</u>	<u>Stainless</u>	<u>OE Steel</u>
PFB8001	Power Disc Brake Line Set 1976-80, 7pc Set	\$175.00	\$145.00
PFB8002	4 Wheel Disc Brake Line Set 1979-80, 7pc Set	\$175.00	\$145.00
PFB8101	Power Disc Brake Line Set 1981, 7pc Set	\$175.00	\$145.00
PFB8102	4 Wheel Disc Brake Line Set 1981, 7pc Set	\$175.00	\$145.00
	<u>Main Fuel Lines</u>		
PFF8001	1980-81 Fuel Line Tank to Pump 2pc, 3/8" Driver Side Routing	\$99.00	\$69.00
PFF8003	1980-81 Fuel Return Line Tank to Pump 2pc, 1/4" Passenger Side Routing	\$99.00	\$69.00
	<u>Fuel Emission Lines</u>		
PFF8004	1980-81 Vapor Lines 2pc, 5/16" Passenger Side Routing	\$99.00	\$69.00
	<u>Transmission Lines</u>		
PFT8001	80-81 Trans Cooler Lines T-350 / T-400 2pc, 5/16"	\$75.00	\$45.00
PFT8002	80-81 Turbo Trans Cooler Lines T-350 2pc, 5/16"	\$75.00	\$45.00
PFT8004	80-81 Trans Mod Line 301Cid	\$35.00	\$25.00
PFT8005	80-81 Turbo TA, Pont 301 Cid Trans Modulator Line 2pc	\$40.00	\$30.00
	<u>Engine Lines</u>		
PFE8009	1980-81 Pont 301 Cid, 140 hp Pump to Carb Line, 1pc	\$30.00	\$25.00
PFE8010	1980-81 Pont 305 Cid, 150 hp Pump to Carb Line, 1pc	\$25.00	\$20.00
PFE8005	1980 Turbo TA, Pont 301 Cid Pump To Carb Line, 1 pc	\$30.00	\$25.00
PFE8006	1980 Turbo TA, Pont 301 Cid Engine Vacuum Line, 1pc	\$14.00	\$12.00
PFE8007	1980 Turbo TA, Pont 301 Cid Oil Pressure Line, 1pc	\$20.00	\$16.00
PFE8008	1980 Turbo TA, Pont 301 Cid Carb to EMS Vacuum Can, 1pc	\$25.00	\$20.00
PFE8101	1981 Turbo TA, Pont 301 Cid Pump To Carb Line, 1 pc	\$30.00	\$25.00
PFE8103	1981 Turbo TA, Pont 301 Cid Oil Pressure Line, 1pc	\$20.00	\$16.00
PFE8104	1981 Turbo TA, Pont 301 Cid Carb to EMS Vacuum Can, 1pc	\$25.00	\$20.00

## 1982-92 Pontiac Firebird/TA

### Full Brake Line Sets

		<u>Stainless</u>	<u>OE Steel</u>
PFB8201	Power Disc Brake Line Set 1982-83, 7pc Set <b>Standard Fittings</b>	\$185.00	\$165.00
PFB8202	4 Wheel Disc Brake Line Set 1982-83, 7pc Set <b>Standard Fittings</b>	\$185.00	\$165.00
PFB8203	Power Disc Brake Line Set 1984-92, 7pc Set <b>Metric Fittings</b>	\$185.00	\$165.00
PFB8204	4 Wheel Disc Brake Line Set 1984-92, 7pc Set <b>Metric Fittings</b>	\$185.00	\$165.00

### Fuel Lines - Carbured

PFF8201	1982-86 Main Fuel Line V8 Tank to Pump 1pc, 3/8" Pass Side Routing, <b>Carbured</b>	\$99.00	\$69.00
PFF8203	1982-86 Fuel Return Line V8 Tank to Pump 1pc, 5/16" Pass Side Routing, <b>Carbured</b>	\$99.00	\$69.00
PFF8204	1982-86 Vapor Lines V8 Tank to Pump 1pc, 1/4" DS Side Routing, <b>Carbured</b>	\$99.00	\$69.00

### Fuel Lines - Fuel Injected

PFF8501	1985-87 Main Fuel Line V8/V6 Tank to Pump 1pc, 3/8" Drivers Side Routing, <b>Fuel Injected</b>	\$99.00	\$69.00
PFF8502	1985-87 Fuel Return Line V8/V6 Tank to Pump 1pc, 5/16" Drivers Side Routing, <b>Fuel Injected</b>	\$99.00	\$69.00
PFF8503	1985-87 Vapor Lines V8/V6 Tank to Pump 1pc, 1/4" PS Side Routing, <b>Fuel Injected</b>	\$99.00	\$69.00
PFF8801	1988-92 Main Fuel Line V8 Tank to Pump 1pc, 3/8" Drivers Side Routing, <b>Fuel Injected</b>	\$99.00	\$69.00
PFF8802	1988-92 Fuel Return Line V8 Tank to Pump 1pc, 5/16" Drivers Side Routing, <b>Fuel Injected</b>	\$99.00	\$69.00
PFF8803	1988-92 Vapor Lines V8 Tank to Pump 1pc, 1/4" PS Side Routing, <b>Fuel Injected</b>	\$99.00	\$69.00
PFF8804	1988-92 Vapor Lines V8 Tank to Canister 1pc, 1/4" DS Side Routing, <b>Fuel Injected</b>	\$99.00	\$69.00

### Transmission Lines

PFT8201	1982-86 Trans Cooler Lines 700R4, 2pc, 5/16"	\$75.00	\$50.00
PFT8202	1982-86 Trans Cooler Lines T-350, 2pc, 5/16"	\$75.00	\$50.00

### Engine Lines

PFE8501	1985 TA Pump To Carb Line 305 CID, 4bbl Standard Engine	\$35.00	\$25.00
PFE8201	1982 TA Pump To Carb Line 5.0L, 305 CID, 4bbl	\$35.00	\$25.00

## 1994 Pontiac Firebird/TA

### Fuel Lines

		<u>Stainless</u>	<u>OE Steel</u>
PFF9401	Main Fuel Line V6 3.4L	\$85.00	\$65.00
PFF9402	Fuel Return Line V6 3.4L	\$85.00	\$65.00
PFF9403	Vapor Line V6 3.4L	\$85.00	\$65.00

When ordering **Stainless Steel Lines**  
Please place a "S" in front of the part number.

