

1967 Full Brake Line Set

1967 Camaro Full Brake Line Sets

	<u>1967 Brake Line Sets</u>	<u>Stainless</u>	<u>OE Steel</u>
CCB6701	1967 Manual Drum 1pc F to R Brake Line Set 7pc	\$175.00	\$139.00
CCB6702	1967 Power Drum 1pc F to R Brake Line Set 7pc	\$175.00	\$139.00
CCB6703	1967 Manual Disc 1pc F to R Brake Line Set 8pc	\$175.00	\$139.00
CCB6704	1967 Power Disc 1pc F to R Brake Line Set 8pc	\$170.00	\$139.00
CCB6705	1967 Manual Drum 2pc F to R Brake Line Set 8pc	\$175.00	\$139.00
CCB6706	1967 Power Drum 2pc F to R Brake Line Set 8pc	\$175.00	\$139.00
CCB6707	1967 Manual Disc 2pc F to R Brake Line Set 9pc	\$175.00	\$139.00
CCB6708	1967 Power Disc 2pc F to R Brake Line Set 9pc	\$170.00	\$139.00

Note: cars with 2 piece front to rear had the brass hold off valve located under the driver side door.

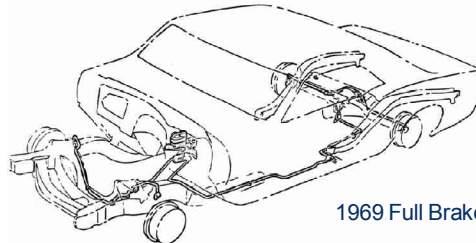

1969 Full Brake Line Set

1969 Camaro Full Brake Line Sets

	<u>1969 Brake Line Sets</u>	<u>Stainless</u>	<u>OE Steel</u>
CCB6901	1969 Manual Drum 1pc F to R Brake Line Set 7pc	\$175.00	\$139.00
CCB6902	1969 Power Drum 1pc F to R Brake Line Set 7pc	\$175.00	\$139.00
CCB6903	1969 Manual Disc 1pc F to R Brake Line Set 8pc	\$175.00	\$139.00
CCB6904	1969 Power Disc 1pc F to R Brake Line Set 8pc	\$170.00	\$139.00
CCB6905	1969 Manual Drum 2pc F to R Brake Line Set 8pc	\$175.00	\$139.00
CCB6906	1969 Power Drum 2pc F to R Brake Line Set 8pc	\$175.00	\$139.00
CCB6907	1969 Manual Disc 2pc F to R Brake Line Set 9pc	\$175.00	\$139.00
CCB6908	1969 Power Disc 2pc F to R Brake Line Set 9pc	\$170.00	\$139.00
CCB6909	1969 Power 4wd Disc 2pc F to R JL8 4wDisc Brake Line Set 9pc	\$185.00	\$160.00

Note: cars with 2 piece front to rear had the brass hold off valve located under the driver side door.

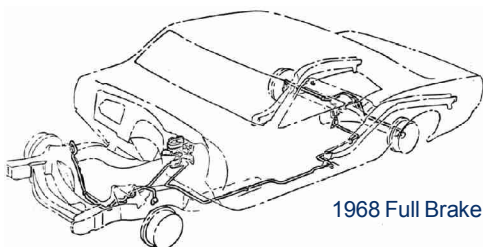

1968 Full Brake Line Set

1968 Camaro Full Brake Line Sets

	<u>1968 Brake Line Sets</u>	<u>Stainless</u>	<u>OE Steel</u>
CCB6801	1968 Manual Drum 1pc F to R Brake Line Set 7pc	\$175.00	\$139.00
CCB6802	1968 Power Drum 1pc F to R Brake Line Set 7pc	\$175.00	\$139.00
CCB6803	1968 Manual Drum 1pc F to R Brake Line Set 8pc	\$175.00	\$139.00
CCB6804	1968 Power Disc 1pc F to R Brake Line Set 8pc	\$170.00	\$139.00
CCB6805	1968 Manual Drum 2pc F to R Brake Line Set 8pc	\$175.00	\$139.00
CCB6806	1968 Power Drum 2pc F to R Brake Line Set 8pc	\$175.00	\$139.00
CCB6807	1968 Manual Disc 2pc F to R Brake Line Set 9pc	\$175.00	\$139.00
CCB6808	1968 Power Disc 2pc F to R Brake Line Set 9pc	\$170.00	\$139.00

Note: Cars with 2 piece front to rear had the brass hold off valve located under the driver side door.



Inline Tube stocks hundreds of OEM rubber flex hoses. All hoses are made exact to the factory original and D.O.T. approved. Page 221



Parking Brake Cables Page 190



Inline Tube carries: brake & fuel lines, parking brake cables, clips and clamps, rubber flex hoses, and any other under chassis parts you will need.

1967 Camaro

Manual Drum Front Line Set

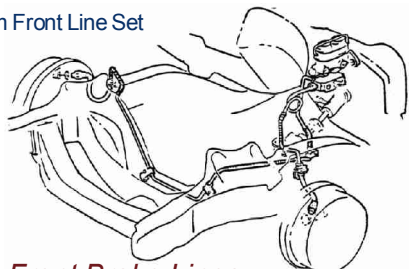

Front Brake Lines

		Stainless	OE Steel
CCB67F1	Manual Drum Brake Line Set 4pc	\$89.00	\$65.00
CCB67F2	Power Drum Brake Line Set 4pc	\$89.00	\$65.00
CCB67F3	Manual Disc Brake Line Set 5pc	\$89.00	\$65.00
CCB67F4	Power Disc Brake Line Set 5pc	\$89.00	\$65.00
CCB67F5	1967-Disc Caliper Lines 2pc (1/2-20 Lt Line, 7/16-24 Rt @caliper)	\$25.00	\$18.00
CCB67F6	1967-Disc Caliper Lines 2pc (3/8-24 Lt Line, 3/8-24 Rt @caliper)	\$25.00	\$18.00

Manual Brakes Front to Rear

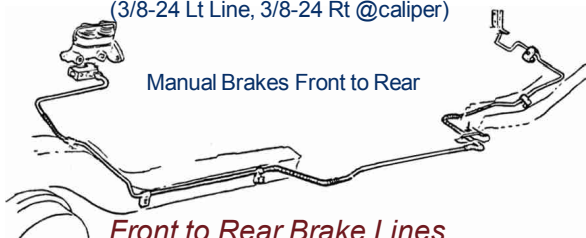

Front to Rear Brake Lines

CCB67M1	Front to Rear Brake Line 1pc, Power Brakes	\$70.00	\$55.00
CCB67M2	Front to Rear Brake Line 2pc, Power Brakes	\$70.00	\$55.00
CCB67M3	Front to Rear Brake Line 1pc, Manual Brakes	\$70.00	\$55.00
CCB67M4	Front to Rear Brake Line 2pc, Manual Brakes	\$70.00	\$55.00

Rear Axle Lines

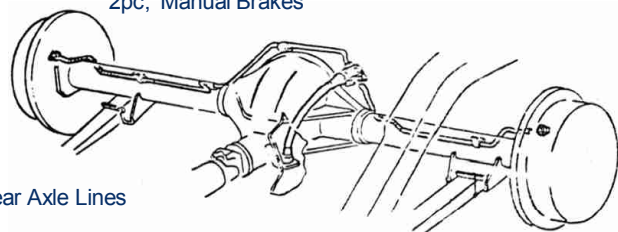

Rear Axle Lines

CCB67R1	Mono Leaf Rear End 2pc	\$35.00	\$25.00
CCB67R2	Multi Leaf Rear End 2pc	\$35.00	\$25.00

Disc Brake Conv. Line Sets

This brake line set is designed to convert Camaros with drum brakes to disc brakes. This kit mounts a prop valve to the right of the master cylinder using the bracket listed below. CCB67D1 is a complete set: Master cyl., Front, Inter, & Axle Lines.

		Stainless	OE Steel
CCB67D1	Power Disc Brake Line Set 8pc	\$165.00	\$139.00
BRK01	1967-69 Prop Mounting Bracket	NA	\$18.00

Brake Clip Sets

CCB201	1967-68 Brake Line Clip Set 10pc		\$28.00
CCF201	1967-68 Fuel Line Clip Set 7pc		\$26.00



If you expect the highest quality parts, with the best service and the lowest price, Inline Tube can meet your expectations.

Rubber Flex Hoses

		OEM
H-579	1967 Front Disc Hose	\$24.00
H-525	1967-69 Front Drum Hose	\$24.00
H-553	1967 Rear Hose (Needs GMTEE02)	\$25.00

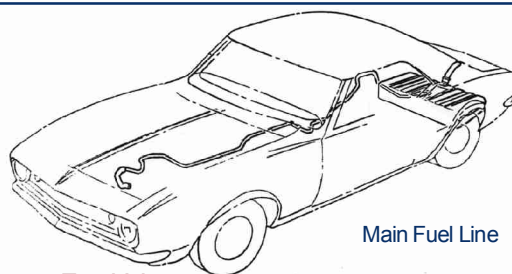

Main Fuel Line

Fuel Lines

		Stainless	OE Steel
CCF6701	Main Fuel Line 1pc 3/8" V8, Rt Side Routing	\$99.00	\$65.00
CCF6702	Main Fuel Line 1pc 5/16" 6cyl Rt Side Routing	\$99.00	\$65.00
CCF6703	Main Fuel Line 1pc 1/2" Oversized Rt Side Routing	\$130.00	NA

Transmission Lines

		Stainless	OE Steel
CCT6701	Power Glide 2pc Set	\$75.00	\$45.00
CCT6702	Turbo 350 2pc Set	\$75.00	\$45.00
CCT6703	Turbo 400 2pc Set	\$75.00	\$45.00
CCT6704	Trans Mod Line Power Glide	\$35.00	\$25.00
CCT6705	Trans Mod Line T-350 1pc	\$35.00	\$25.00
CCT6706	Trans Mod Line T-400 1pc	\$35.00	\$25.00

Engine Lines 1967-68

		Stainless	OE Steel
CCE6701	Pump to Carb Line Big Block 396cid 350/375 Holley 3pc	\$39.00	\$29.00
CCE6706	Pump to Carb Line Big Block 396cid 325, 1pc	\$25.00	\$20.00
CCE6702	Pump to Carb Line 350 4bbl 295 HP 1pc	\$25.00	\$20.00
CCE6703	Pump to Carb Line 327 2bbl 210 HP 1pc, 5/16" tubing	\$25.00	\$20.00
CCE6708	Pump to Carb Line 327 2bbl 210 HP 1pc, 3/8" tubing swedged down to 5/16 @carb	\$25.00	\$20.00
CCE6704	Pump to Carb Line 327 4bbl 275 HP 1pc	\$25.00	\$20.00
CCE6705	Pump to Carb Line 302 4bbl 290 HP 3pc	\$39.00	\$29.00
CCE6710	Pump to Carb Brass Fuel Block Used to Connect 3pc Line Set	N/A	\$18.00

Vacuum Advance Lines

CCV6801	67-68 Vac Advance - Small Block	\$12.00	\$10.00
CCV6802	67-68 Vac Advance - Big Block	\$12.00	\$10.00

1968 Camaro

Manual Drum Front Line Set

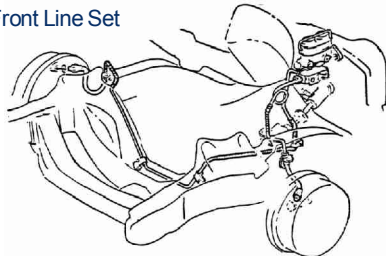

Front Brake Lines

		Stainless	OE Steel
CCB68F1	Manual Drum Brake Line Set 4pc	\$89.00	\$65.00
CCB68F2	Power Drum Brake Line Set 4pc	\$89.00	\$65.00
CCB68F3	Manual Disc Brake Line Set 5pc	\$89.00	\$65.00
CCB68F4	Power Disc Brake Line Set 5pc	\$89.00	\$65.00
CCB68F5	1967-Disc Caliper Lines 2pc (1/2-20 Lt Line, 7/16-24 Rt @caliper)	\$25.00	\$18.00
CCB68F6	1967-Disc Caliper Lines 2pc (3/8-24 Lt Line, 3/8-24 Rt @caliper)	\$25.00	\$18.00

Manual Brakes Front to Rear Brake Line

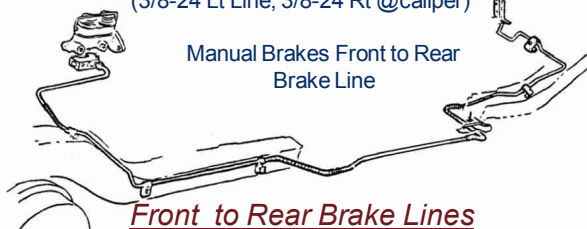

Front to Rear Brake Lines

CCB68M1	Front to Rear Brake Line 1pc, Power Brakes	\$70.00	\$55.00
CCB68M2	Front to Rear Brake Line 2pc, Power Brakes	\$70.00	\$55.00
CCB68M3	Front to Rear Brake Line 1pc, Manual Brakes	\$70.00	\$55.00
CCB68M4	Front to Rear Brake Line 2pc, Manual Brakes	\$70.00	\$55.00

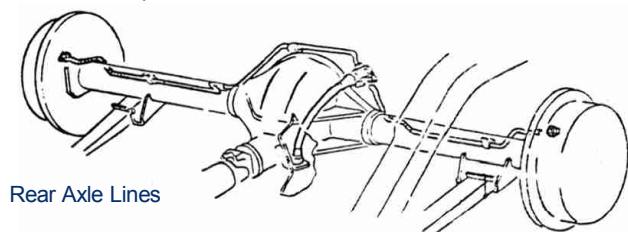

Rear Axle Lines

Rear Axle Lines

CCB68R1	Mono Leaf Rear End 2pc	\$35.00	\$25.00
CCB68R2	Multi Leaf Rear End 2pc	\$35.00	\$25.00

Disc Brake Conv. Line Sets

This brake line set is designed to convert Camaros with drum brakes to disc brakes. This kit mounts a prop valve to the right of the master using the bracket listed below. CCB68D1 is a complete set: Master cyl., Front, Inter, & Axle Lines.

CCB68D1	Power Disc Brake Line Set 8pc	\$165.00	\$139.00
BRK01	1967-69 Prop Mounting Bracket	N/A	\$18.00
CCB67D3	1967-69 Prop Valve	N/A	\$85.00

Brake Clip Sets

		OEM
CCB201	1967-68 Brake Line Clip Set 10pc	\$28.00
CCF201	1967-68 Fuel Line Clip Set 7pc	\$26.00



Rubber Flex Hoses

		OEM
H-579	1967-68 Front Disc Hose	\$24.00
H-525	1967-69 Front Drum Hose	\$24.00
H-581	1968 Rear Hose (Needs GMTEE02)	\$25.00

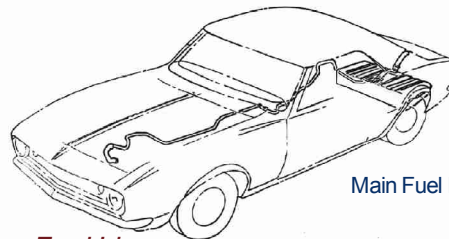

Main Fuel Line

Fuel Lines

		Stainless	OE Steel
CCF6801	Main Fuel Line 1pc 3/8" V8 Rt Side Routing	\$99.00	\$65.00
CCF6802	Main Fuel Line 1pc 5/16" V8 Rt Side Routing	\$99.00	\$65.00
CCF6803	Main Fuel Line 1pc 1/2" Oversized Rt Side Routing V8	\$130.00	NA
CCF6804	Main Fuel Line 1pc 5/16" 6cyl Rt Side Routing	\$99.00	\$65.00

Transmission Lines

		Stainless	OE Steel
CCT6801	Power Glide 2pc Set V8 only	\$75.00	\$45.00
CCT6802	Turbo 350 2pc Set V8 only	\$75.00	\$45.00
CCT6803	Turbo 400 2pc Set V8 only	\$75.00	\$45.00
CCT6804	Trans Mod Line Power Glide V8 only	\$35.00	\$25.00
CCT6805	Trans Mod Line T-350 V8 only	\$35.00	\$25.00
CCT6806	Trans Mod Line T-400 V8 only	\$35.00	\$25.00

Engine Lines 1967-68

		Stainless	OE Steel
CCE6801	Pump to Carb Line Big Block 396cid 350/375 Holley 3pc	\$39.00	\$29.00
CCE6806	Pump to Carb Line Big Block 396cid 325 1pc	\$25.00	\$20.00
CCE6802	Pump to Carb Line 350 4bbl 295 HP 1pc	\$25.00	\$20.00
CCE6803	Pump to Carb Line 327 2bbl 210 HP 1pc, 5/16" tubing	\$25.00	\$20.00
CCE6808	Pump to Carb Line 327 2bbl 210 HP 1pc, 3/8" tubing swedged down to 5/16 @carb	\$25.00	\$20.00
CCE6804	Pump to Carb Line 327 4bbl 275 HP 1pc	\$25.00	\$20.00
CCE6805	Pump to Carb Line Holley 302 4bbl 290 HP 3pc	\$39.00	\$29.00
CCE6807	68 Pump to Carb Line Big Block 427cid 385HP/425HP 3pc Holley	\$39.00	\$29.00
CCE6812	68 Pump to Carb Line 307 2bbl 200 HP 3/8" Line w/5/16 Fit At Carb 1pc	\$25.00	\$20.00
CCE6810	Pump to Carb Brass Fuel Block Used to Connect 3pc Line Set	NA	\$18.00

Vacuum Advance Lines

CCV6801	67-68 Vac Advance - Small Block	\$12.00	\$10.00
CCV6802	67-68 Vac Advance - Big Block	\$12.00	\$10.00

1969 Camaro

Manual Drum Front Line Set



Front Brake Lines

		<u>Stainless</u>	<u>OE Steel</u>
CCB69F1	Manual Drum Brake Line Set 4pc	\$89.00	\$65.00
CCB69F2	Power Drum Brake Line Set 4pc	\$89.00	\$65.00
CCB69F3	Manual Disc Brake Line Set 5pc	\$89.00	\$65.00
CCB69F4	Power Disc Brake Line Set 5pc	\$89.00	\$65.00
CCB69F5	1969-Disc Caliper Lines 2pc (1/2-20 Lt Line, 7/16-24 Rt @caliper) (JL8 ONLY)	\$25.00	\$18.00
CCB69F6	1969-Disc Caliper Lines 2pc (3/8-24 Lt Line, 3/8-24 Rt @caliper) (JL8 ONLY)	\$25.00	\$18.00

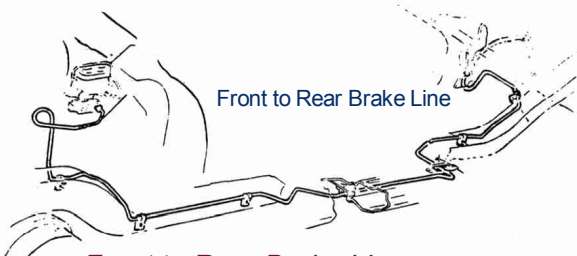

Front to Rear Brake Line

Front to Rear Brake Lines

CCB69M1	Front to Rear Brake Line 1pc, Power Brakes	\$75.00	\$60.00
CCB69M2	Front to Rear Brake Line 2pc, Power Brakes	\$75.00	\$60.00
CCB69M3	Front to Rear Brake Line 1pc, Manual Brakes	\$75.00	\$60.00
CCB69M4	Front to Rear Brake Line 2pc, Manual Brakes	\$75.00	\$60.00

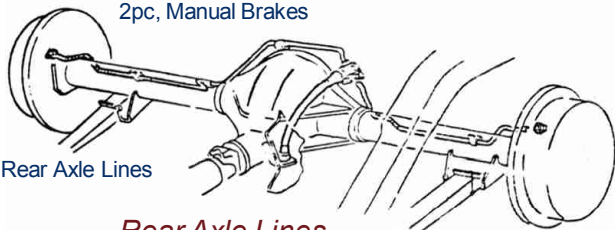

Rear Axle Lines

Rear Axle Lines

CCB69R1	Mono Leaf Rear End 2pc	\$35.00	\$25.00
CCB69R2	Multi Leaf Rear End 2pc	\$35.00	\$25.00
CCB69R3	JL8 Factory Disc Brakes	\$38.00	\$28.00

Disc Brake Conv. Line Sets

This brake line set is designed to convert Camaros with drum brakes to disc brakes. This kit mounts a prop valve to the right of the master using the bracket listed below. CCB69D1 is a complete set: Master cyl., Front, Inter, & Axle Lines.

CCB69D1	Power Disc Brake Line Set 8pc	\$165.00	\$139.00
BRK01	1967-69 Prop Mounting Bracket	N/A	\$18.00
CFB67D3	1967-69 Prop Valve	N/A	\$85.00

Brake Clip Sets

		<u>OEM</u>
CCB202	1969 Brake Line Clip Set 25pc	\$35.50
CCF202	1969 Fuel Line Clip Set 7pc No Return	\$18.00
CCF203	1969 Fuel Line Clip Set 7pc Return	\$26.00



Inline Tube does not install the parts, we manufacture only the highest quality parts on the market.



Rubber Flex Hoses

		<u>OEM</u>
H-672	1969-71 Front Disc Hose	\$25.00 ea
H-525	1967-69 Front Drum Hose	\$24.00 ea
H-586	1969 Rear Hose	\$25.00 ea

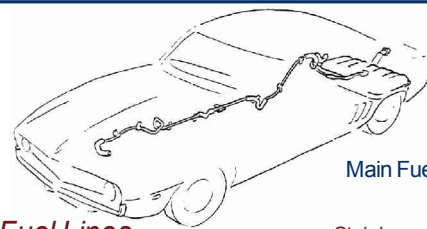

Main Fuel Line

Fuel Lines

		<u>Stainless</u>	<u>OE Steel</u>
CCF6901	Main Fuel Line 1pc 3/8" V8 Rt Side Routing	\$99.00	\$65.00
CCF6902	Main Fuel Line 1pc 5/16" 6cyl Rt Side Routing	\$99.00	\$65.00
CCF6903	Fuel Return Line 1pc 1/4" Rt Side Routing	\$95.00	\$65.00
CCF6904	Main Fuel Line 1pc 1/2" Oversized Rt Side Routing	\$130.00	N/A

Transmission Lines

		<u>Stainless</u>	<u>OE Steel</u>
CCT6901	Cooler Lines Power Glide 2pc	\$75.00	\$45.00
CCT6902	Cooler Lines Turbo 350-400 2pc	\$75.00	\$45.00
CCT6903	Trans Mod Line Power Glide	\$35.00	\$25.00
CCT6904	Trans Mod Line T-350	\$35.00	\$25.00
CCT6905	Trans Mod Line T-400	\$35.00	\$25.00

Engine Lines 1969

		<u>Stainless</u>	<u>OE Steel</u>
CCE6901	Pump to Carb Line Big Block 396cid 350/375 Holley 3pc	\$39.00	\$29.00
CCE6907	Pump to Carb Line 396 4bbl 325 HP 3pc, w/Rochester	\$39.00	\$29.00
CCE6902	Pump to Carb Line 350 4bbl 255 HP 3pc, w/Rochester	\$39.00	\$29.00
CCE6906	Pump to Carb Line 350 4bbl 300 HP, w/3pc Set Holly	\$39.00	\$29.00
CCE6903	Pump to Carb Line 327 2bbl 210 HP 1pc	\$25.00	\$20.00
CCE6908	Pump to Carb Line 307 2bbl 200 HP 3/8" Line w/5/16 Fit At Carb 1pc	\$25.00	\$20.00
CCE6904	Pump to Carb Line 327 4bbl 235 HP 1pc	\$25.00	\$20.00
CCE6905	Pump to Carb Line 302 4bbl 350 HP 3pc Set Holly	\$39.00	\$29.00
CCE6910	Pump to Carb Brass Fuel Block Used to Connect 3pc Line Set	N/A	\$18.00
CCE6911	Cross-Ram Setup 5pc	\$45.00	\$35.00

Vacuum Advance Lines

CCV6901	69 Vac Advance - Small Block	\$12.00	\$10.00
CCV6902	69 Vac Advance - Big Block	\$12.00	\$10.00

1970-74 Chevrolet Camaro

71-73 Full Brake Line Set

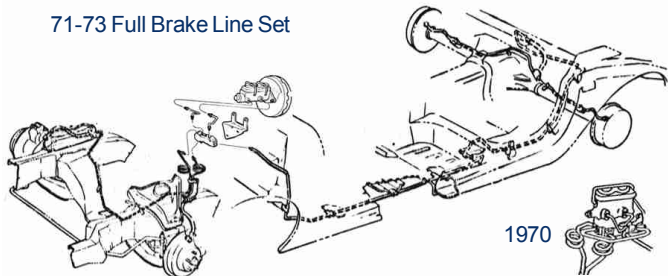

1970

Full Brake Line Sets

		<u>Stainless</u>	<u>OE Steel</u>
CCB7001	Power Disc Brake Line Set 1970 only, 10pc Set	\$185.00	\$155.00
CCB7002	Manual Disc Brake Line Set 1970 only, 10pc Set	\$185.00	\$155.00
CCB7101	Power Disc Brake Line Set 1971-73, 7pc Set	\$175.00	\$145.00
CCB7102	Manual Disc Brake Line Set 1971-73, 7pc Set	\$175.00	\$145.00
CCB7401	Power Disc Brake Line Set 1974-75, 7pc Set	\$175.00	\$145.00
CCB7402	Manual Disc Brake Line Set 1974-75, 7pc Set	\$175.00	\$145.00

Rubber Flex Hose

		<u>OEM</u>
H-672	1969-71 Front Disc Hose	\$25.00 ea

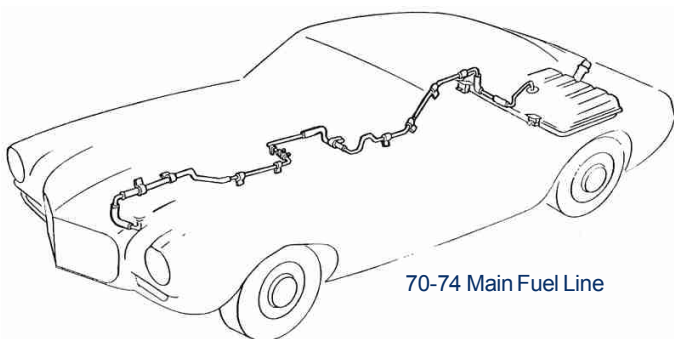

70-74 Main Fuel Line

Main Fuel Lines

CCF7001	1970-71 Fuel Line Tank to Pump 2pc, 3/8" Pass Side Routing - With Spring Guard	\$99.00	\$69.00
CCF7003	1970-71 Fuel Return Line Tank to Pump 1/4", 2pc PS Routing - With Spring Guard	\$99.00	\$69.00
CCF7006	1972-73 Fuel Line Tank to Pump 2pc, 3/8" Pass Side Routing - No Spring Guard	\$99.00	\$69.00
CCF7007	1972-73 Fuel Return Line Tank to Pump 1/4", 2pc PS Routing - No Spring Guard	\$99.00	\$69.00
CCF7008	1974 Fuel Line Tank to Pump 2pc, 3/8" Pass Side Routing	\$99.00	\$69.00
CCF7009	1974 Fuel Return Line Tank to Pump 1/4", 2pc PS Routing	\$99.00	\$69.00



1971-78 Proportioning Valve

VCH116	1971-78 Chevy Camaro Disc/ Drum Prop. Valve	\$85.00
--------	---	---------

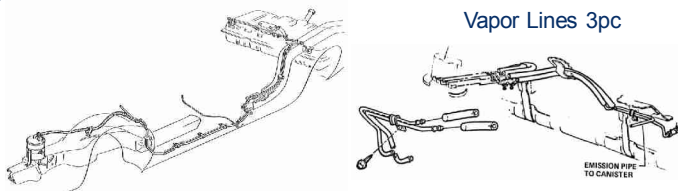

Vapor Lines 3pc

EMISSION PIPE
TO CANISTER

Fuel Emission Lines

		<u>Stainless</u>	<u>OE Steel</u>
CCF7004	1971-74 Main Vapor Line 1pc DS Routing	\$99.00	\$69.00
CCF7005	1971-74 Vapor Lines 3pc	\$39.00	\$29.00

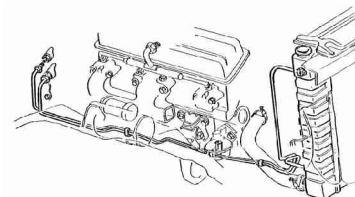

Transmission Lines

CCT7001	1970 & 72 -74 Trans Cooler Lines Turbo 350, 2pc, 5/16" tube, 1/2-20 thread	\$75.00	\$45.00
CCT7002	1970 & 72 -74 Trans Cooler Lines Turbo 400, 2pc, 5/16" tube, 1/2-20 thread	\$75.00	\$45.00
CCT7101	1971 only Trans Cooler Lines Turbo 350, 2pc, 5/16" tube Red Nuts 5/8-18 thread	\$75.00	\$45.00
CCT7102	1971 only Trans Cooler Lines Turbo 400, 2pc, 5/16" tube Red Nuts 5/8-18 thread	\$75.00	\$45.00

Transmission Modulator Line

CCT7003	1970-74 Mod Line 1pc T-350	\$35.00	\$25.00
CCT7004	1970-74 Mod Line 1pc T-400	\$35.00	\$25.00

Engine Lines

CCE7001	70-72 Pump to Carb 302 350 HP 3pc, Holley Dual Feed	\$39.00	\$29.00
CCE7002	70-72 Pump to Carb 396 350/375 HP 3pc, Holley Dual Feed	\$39.00	\$29.00
CCE7006	Pump to Carb Brass Fuel Block Used to Connect 3pc Line Set	N/A	\$18.00
CCE7003	70-72 Pump to Carb 350 4bbl 300 HP 3pc, Rochester	\$25.00	\$20.00
CCE7004	70-72 Pump to Carb 350 2bbl 250 HP 1pc Set	\$25.00	\$20.00
CCE7005	70-71 Pump to Carb Line 307 2bbl 200 HP 3/8" Line w/5/16 Fit At Carb 1pc	\$25.00	\$20.00
CCE7303	70-72 Z28 w/Holley Carb to Power Booster	\$20.00	\$16.00
CCE7007	70 Pump to Carb 396 Cid Rochester Carb with filter & return 3 pc	\$39.00	\$29.00
CCE7008	70 TCS Lines 396 Cid Rochester Carb With TCS Switch	\$32.00	\$25.00
CCE7301	73-74 Pump to Carb 350 4bbl 245HP 1pc Set	\$25.00	\$20.00
CCE7302	73-74 Pump to Carb 350 2bbl 145/175 HP 1pc Set	\$25.00	\$20.00
CCE7010	70 Pump to Carb 454 4bbl, 5 pc Holley with Brass Tee, and filter & Return Line	\$59.00	\$49.00

When ordering **Stainless Steel Lines** Please place a "S" in front of the part number.

1975-77 Chevrolet Camaro

76-77 Full Brake Line Set

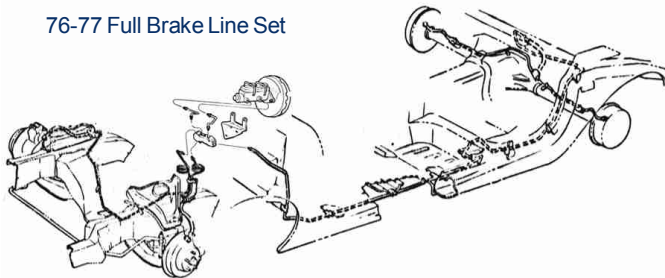

Full Brake Line Sets

		<u>Stainless</u>	<u>OE Steel</u>
CCB7501	Power Disc Brake Line Set 1974-75, 7pc Set	\$175.00	\$145.00
CCB7502	Manual Disc Brake Line Set 1974-75, 7pc Set	\$175.00	\$145.00
CCB7601	Power Disc Brake Line Set 1976-77, 7pc Set	\$175.00	\$145.00
CCB7602	Manual Disc Brake Line Set 1976-77, 7pc Set	\$175.00	\$145.00
CCB75Z1	Power Disc Brake Line Set 1974-75, 7pc Set Z-28 Only	\$175.00	\$145.00
CCB75Z2	Manual Disc Brake Line Set 1974-75, 7pc Set Z-28 Only	\$175.00	\$145.00
CCB76Z1	Power Disc Brake Line Set 1976-77, 7pc Set Z-28 Only	\$175.00	\$145.00
CCB76Z2	Manual Disc Brake Line Set 1976-77, 7pc Set Z-28 Only	\$175.00	\$145.00

Main Fuel Lines

CCF7501	1975-77 Fuel Line Tank to Pump 2pc, 3/8" Pass Side Routing	\$99.00	\$69.00
CCF7503	1975-77 Fuel Return Line 2pc Tank to Pump 1/4" PS Routing	\$99.00	\$69.00

Fuel Emission Lines

CCF7504	1975-77 Main Vapor Line 1pc DS Routing	\$99.00	\$69.00
---------	---	---------	---------

Transmission Lines

CCT7501	1975-81 Trans Cooler Lines Turbo 350, 2pc, 5/16"	\$75.00	\$45.00
CCT7502	1975-81 Trans Cooler Lines Turbo 400, 2pc, 5/16"	\$75.00	\$45.00

Transmission Modulator Lines

CCT7503	Trans Mod Line 1pc T-350	\$35.00	\$25.00
CCT7504	Trans Mod Line 1pc T-400	\$35.00	\$25.00

Engine Lines

CCE7501	1975-77 Pump to Carb 2bbl, V8	\$25.00	\$20.00
CCE7505	1975-77 Pump to Carb 4bbl, V8 Short Pump - Low Perf	\$25.00	\$20.00
CCE7507	1975-77 Pump to Carb 4bbl, V8 Long Pump - High Perf	\$25.00	\$20.00
CCE7502	1975-77 Choke Tubes 2bbl, V8	\$25.00	\$20.00
CCE7503	1975-77 Choke Tubes 4bbl, V8	\$25.00	\$20.00
CCE7504	1975-77 Carb to Power Booster Vacuum Line 2bbl/4bbl, V8	\$16.00	\$12.00
CCE7506	Power Steering Return Line	\$25.00	\$18.00

1978-79 Chevrolet Camaro

78-79 Full Brake Line Set

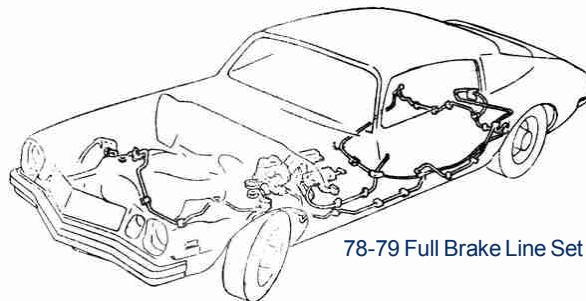

Full Brake Line Sets

		<u>Stainless</u>	<u>OE Steel</u>
CCB7801	Power Disc Brake Line Set 1978-80, 7pc Set	\$175.00	\$145.00
CCB7802	Manual Disc Brake Line Set 1978-80, 7pc Set	\$175.00	\$145.00
CCB78Z1	Power Disc Brake Line Set 1978-80, 7pc Set Z-28 ONLY	\$175.00	\$145.00
CCB78Z2	Manual Disc Brake Line Set 1978-80, 7pc Set Z-28 ONLY	\$175.00	\$145.00

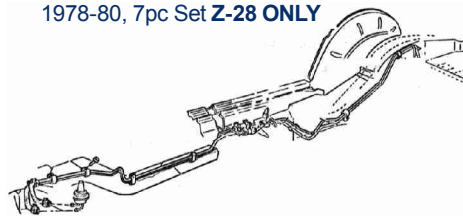

Main Fuel Lines

CCF7801	1978-79 Fuel Line Tank to Pump 2pc, 3/8" Pass Side Routing	\$99.00	\$69.00
CCF7802	1978-79 Fuel Line Tank to Pump 1pc, 1/2" Oversized Pass Side Routing	\$140.00	N/A
CCF7803	1978-79 Fuel Return Line Tank to Pump 1/4" PS Routing	\$99.00	\$69.00

Fuel Emission Lines

CCF7804	1978-79 Vapor Lines 1pc DS Side Routing	\$99.00	\$69.00
CCFF7805	1979-81 Vapor Tank Line 1pc	\$45.00	\$35.00

Transmission Lines

CCT7801	1975-81 Trans Cooler Lines Turbo 350, 2pc, 5/16"	\$75.00	\$45.00
CCT7802	1975-81 Trans Cooler Lines Turbo 400, 2pc, 5/16"	\$75.00	\$45.00

Transmission Modulator Lines

CCT7803	Trans Mod Line 1pc T-350	\$35.00	\$25.00
CCT7804	Trans Mod Line 1pc T-400	\$35.00	\$25.00

Engine Lines

CCE7801	1978-79 Pump to Carb 2bbl, V8	\$25.00	\$20.00
CCE7802	1978-79 Pump to Carb 4bbl, V8 Short Pump - Low Perf	\$25.00	\$20.00
CCE7807	1978-79 Pump to Carb 4bbl, V8 Long Pump - High Perf	\$25.00	\$20.00
CCE7803	1978-79 Choke Tubes 2bbl, V8	\$25.00	\$20.00
CCE7804	1978-79 Choke Tubes 4bbl, V8	\$25.00	\$20.00
CCE7805	1978-79 Carb to Power Booster Vacuum Line 2bbl/4bbl, V8	\$15.00	\$10.00
CCE7806	Power Steering Return Line	\$25.00	\$18.00

Inline Tube is on the Internet. See our online catalog: www.InlineTube.com

1980-81 Chevrolet Camaro

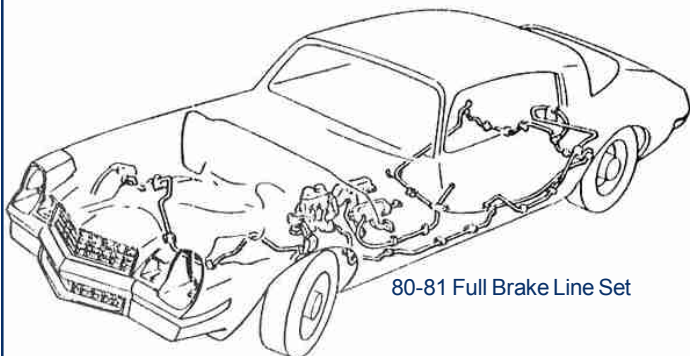

80-81 Full Brake Line Set

Full Brake Line Sets

		<u>Stainless</u>	<u>OE Steel</u>
CCB8001	Power Disc Brake Line Set 1978-80, 7pc Set	\$175.00	\$145.00
CCB8002	Manual Disc Brake Line Set 1978-80, 7pc Set	\$175.00	\$145.00
CCB8101	Power Disc Brake Line Set 1981, 7pc Set	\$175.00	\$145.00
CCB8102	Manual Disc Brake Line Set 1981, 7pc Set	\$175.00	\$145.00
CCB80Z1	Power Disc Brake Line Set 1978-80, 7pc Set Z-28 Only	\$175.00	\$145.00
CCB80Z2	Manual Disc Brake Line Set 1978-80, 7pc Set Z-28 Only	\$175.00	\$145.00
CCB81Z1	Power Disc Brake Line Set 1981, 7pc Set Z-28 Only	\$175.00	\$145.00
CCB81Z2	Manual Disc Brake Line Set 1981, 7pc Set Z-28 Only	\$175.00	\$145.00

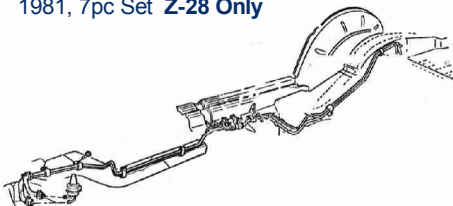

Main Fuel Lines

CCF8001	1980-81 Fuel Line Tank to Pump 2pc, 3/8" Pass Side Routing	\$99.00	\$69.00
CCF8002	1980-81 Fuel Line Tank to Pump 2pc, 1/2" Oversized Pass Side Routing	\$140.00	N/A
CCF8003	1980-81 Fuel Return Line Tank to Pump 1/4" PS Routing	\$99.00	\$69.00

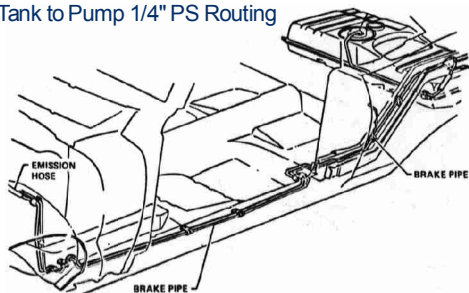

Fuel Emission Lines

CCF8004	1980-81 Vapor Lines 2pc DS Side Routing	\$99.00	\$69.00
---------	--	---------	---------

1980-81 Chevrolet Camaro

Transmission Lines

		<u>Stainless</u>	<u>OE Steel</u>
CCT8001	1975-81 Trans Cooler Lines Turbo 350, 2pc, 5/16"	\$75.00	\$45.00
CCT8002	1975-81 Trans Cooler Lines Turbo 400, 2pc, 5/16"	\$75.00	\$45.00
CCT8003	1980 Trans Modulator Line Turbo 350, 1pc 4bbl V8	\$35.00	\$25.00

Engine Lines

CCE8001	1980 Pump to Carb Line 4bbl, V8	\$25.00	\$18.00
CCE8002	1980-81 Pump to Carb 2bbl, V8	\$25.00	\$18.00
CCE8003	1980-81 Choke Tubes 2bbl, V8	\$25.00	\$18.00
CCE8004	1980-81 Choke Tubes 4bbl, V8	\$25.00	\$18.00
CCE8005	1980-81 Carb to Power Booster Vacuum Line 2bbl, V8	\$15.00	\$10.00
CCE8006	Power Steering Return Line	\$25.00	\$18.00

Quick Tip: Fluid

DOT 3 originally came in the brake system. This fluid can destroy your paint and collects moisture which over time reduces performance. Under extreme braking conditions (constant drag racing) or excessive braking, Dot 3 will not perform DOT 5 (silicone fluid). DOT 5 is an excellent choice for museum cars since it will not collect moisture and does not harm paint. Never mix DOT 5 & DOT 3 fluids.

1971-81 Proportioning Valve



VCH116 1971-81 Chevy Camaro Disc/ Drum Prop.Valve \$85.00



Clip Sets Available for Chevrolet cars Pg 229



Parking Brake Cables Page 190

Rubber Fuel Line Sets

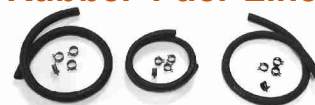

Rubber Fuel Lines

FHS-301	3/8" (2') hose with 4 correct color clips Used for both ends of Main Fuel Line	\$4.50
FHS-302	5/16" (2') hose with 4 correct color clips Used for Main Fuel Line or Vapor Line	\$4.50
FHS-303	1/4" (2') hose with 4 correct color clips Used for Fuel Return Line	\$4.50

1982-92 Chevrolet Camaro

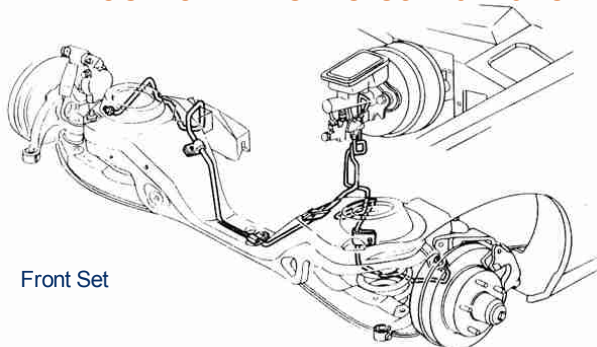

Front Set

Front Brake Line

		<u>Stainless</u>	<u>OE Steel</u>
CCB82F1	Power Disc Front Line Set 1982-83, 4pc, Standard Fittings	\$90.00	\$65.00
CCB82F3	Power Disc Front Line Set 1984-92, 4pc, Metric Fittings	\$90.00	\$65.00

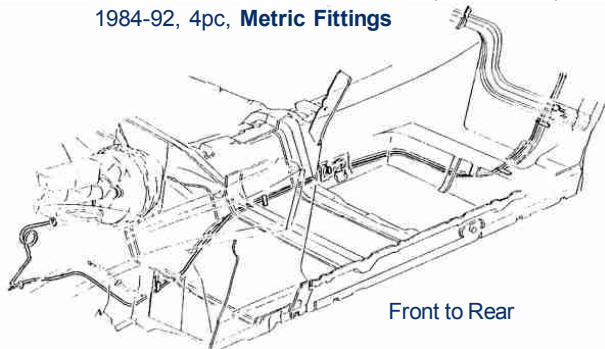

Front to Rear

Front to Rear Brake Line

CCB82M1	Power Disc Front to Rear Line 1982-83, 1pc, Standard Fittings	\$80.00	\$60.00
CCB82M3	Power Disc Front to Rear Line 1984-85, 1pc, Metric Fittings	\$80.00	\$60.00
CCB82M4	Power Disc Front to Rear Line 1986-92, 1pc, Metric Fittings	\$80.00	\$60.00

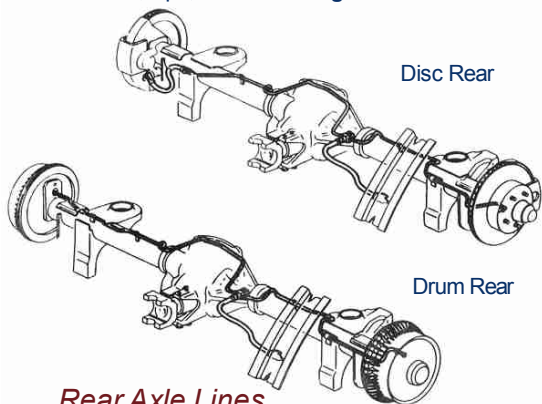

Disc Rear

Drum Rear

Rear Axle Lines

CCB82R1	Rear Axle Lines - Drum Rear 1982-83, 2pc, Standard Fittings	\$35.00	\$29.00
CCB82R2	Rear Axle Lines- Disc Rear 1982-83, 2pc, Standard Fittings	\$35.00	\$29.00
CCB82R3	Rear Axle Lines - Drum Rear 1984-92, 2pc, Metric Fittings	\$35.00	\$29.00
CCB82R4	Rear Axle Lines- Disc Rear 1984-92, 2pc, Metric Fittings	\$35.00	\$29.00

1982-92 Chevrolet Camaro

Full Brake Line Sets

		<u>Stainless</u>	<u>OE Steel</u>
CCB8201	Power Disc Brake Line Set 1982-83, 7pc, Standard Fittings	\$185.00	\$155.00
CCB8202	4 Wheel Disc Brake Line Set 1982-83, 7pc, Standard Fittings	\$185.00	\$155.00
CCB8203	Power Disc Brake Line Set 1984-92, 7pc, Metric Fittings	\$185.00	\$155.00
CCB8204	4 Wheel Disc Brake Line Set 1984-92, 7pc, Metric Fittings	\$185.00	\$155.00

Fuel Lines - Carbureted

CCF8201	1982-86 Main Fuel Line, V8 Tank to Pump, 1pc, 3/8" Pass Side Routing, Carburated	\$99.00	\$69.00
CCF8203	1982-86 Fuel Return Line, V8 Tank to Pump, 1pc, 5/16" Pass Side Routing, Carburated	\$99.00	\$69.00
CCF8204	1982-86 Vapor Lines, V8 Tank to Pump, 1pc, 1/4" DS Side Routing, Carburated	\$99.00	\$69.00

Fuel Lines - Fuel Injected

CCF8501	1985-87 Main Fuel Line, V8 Tank to Pump, 1pc, 3/8" Drivers Side Routing, Fuel Injected	\$99.00	\$69.00
CCF8502	1985-87 Fuel Return Line, V8 Tank to Pump, 1pc, 5/16" Drivers Side Routing, Fuel Injected	\$99.00	\$69.00
CCF8503	1985-87 Vapor Lines, V8 Tank to Pump, 1pc, 1/4" PS Side Routing, Fuel Injected	\$99.00	\$69.00
CCF8801	1988-92 Main Fuel Line, V8 Tank to Pump, 2pc, 3/8" Drivers Side Routing, Fuel Injected	\$99.00	\$69.00
CCF8802	1988-92 Fuel Return Line, V8 Tank to Pump, 1pc, 5/16" Drivers Side Routing, Fuel Injected	\$99.00	\$69.00
CCF8803	1988-92 Vapor Lines, V8 Tank to Pump, 1pc, 1/4" PS Side Routing, Fuel Injected	\$99.00	\$69.00
CCF8804	1988-92 Vapor Lines, V8 Tank to Pump, 1pc, 1/4" DS Side Routing, Fuel Injected	\$99.00	\$69.00

Transmission Lines

CCT8201	1982-86 Trans Cooler Lines 700R4, 2pc, 5/16"	\$75.00	\$45.00
---------	---	---------	---------

Engine Lines

CCE8601	1984-86 Pump to Carb 4bbl V8 Z-28 305 Q-jet	\$25.00	\$20.00
CCE8602	1984-86 Power Steering Return Z-28 305 Q-jet	\$70.00	\$55.00

1993-96 Chevrolet Camaro

Full Brake Line Sets

		<u>Stainless</u>	<u>OE Steel</u>
CCB9301	4WD Disc Brake Line Set 1993-96, 7pc, LT1, Auto Trans	\$185.00	\$165.00

See our online catalog: www.InlineTube.com