

## Full Brake Line Sets 1964

		<u>Stainless</u>	<u>OE Steel</u>
CHB6405	1964 Manual Drum	\$165.00	\$139.00
	Brake Line Set 6pc, Hardtop		
CHB6407	1964 Power Drum	\$165.00	\$139.00
	Brake Line Set 6pc, Hardtop		
<u>1964 Convertible</u>			
CHB6406	1964 Manual Drum	\$165.00	\$139.00
	Brake Line Set 6pc, Conv.		
CHB6408	1964 Power Drum	\$165.00	\$139.00
	Brake Line Set 6pc, Conv.		

CH B6501 - Manual Drum Brake Line set

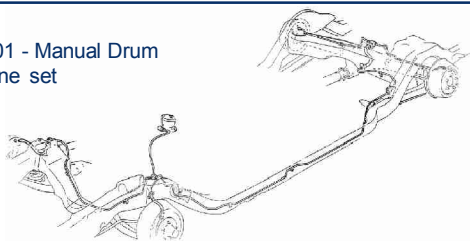

## Full Brake Line Sets 1965

		<u>Stainless</u>	<u>OE Steel</u>
CHB6501	1965 Manual Drum, <b>SS Only</b>	\$165.00	\$139.00
	Brake Line Set 6pc, Hardtop		
CHB6502	1965 Manual Drum, <b>SS Only</b>	\$165.00	\$139.00
	Brake Line Set 6pc, Conv.		
CHB6503	1965 Power Drum, <b>SS Only</b>	\$165.00	\$139.00
	Brake Line Set 6pc, Hardtop		
CHB6504	1965 Power Drum, <b>SS Only</b>	\$165.00	\$139.00
	Brake Line Set 6pc, Conv.		
CHB6505	1965 Manual Drum	\$165.00	\$139.00
	Brake Line Set 6pc, Hardtop		
CHB6506	1965 Manual Drum	\$165.00	\$139.00
	Brake Line Set 6pc, Conv.		
CHB6507	1965 Power Drum	\$165.00	\$139.00
	Brake Line Set 6pc, Hardtop		
CHB6508	1965 Power Drum	\$165.00	\$139.00
	Brake Line Set 6pc, Conv.		

(Note: SS Cars had a front crossover that ran away from the exhaust manifold to keep heat from the brake line.)



BLK100

BLK101

BLK102

BLK103

BLK100	64-65 A-Body Stock Tee (Single Master)	\$24.00
BLK101	66 A-Body Stock Tee (Single Master)	\$24.00
BLK102	64-65 A-Body (Dual Master Conversion Tee)	\$39.00
BLK103	66 A-Body (Dual Master Conversion Tee)	\$39.00



BLK102LP	64-65 A-Body (Dual M/C Block & Lines)	\$69.00
BLK103LP	66 A-Body (Dual M/C Block & Lines)	\$69.00

CHB6605-Manual Drum Brake Line Set

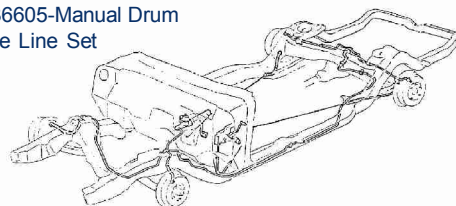

## Full Brake Line Sets 1966

		<u>Stainless</u>	<u>OE Steel</u>
CHB6601	1966 Manual Drum, <b>SS Only</b>	\$165.00	\$139.00
	Brake Line Set 6pc, Hardtop		
CHB6602	1966 Manual Drum, <b>SS Only</b>	\$165.00	\$139.00
	Brake Line Set 6pc, Conv.		
CHB6603	1966 Power Drum, <b>SS Only</b>	\$165.00	\$139.00
	Brake Line Set 6pc, Hardtop		
CHB6604	1966 Power Drum, <b>SS Only</b>	\$165.00	\$139.00
	Brake Line Set 6pc, Conv.		
<u>1966 Non SS Model</u>			
CHB6605	1966 Manual Drum	\$165.00	\$139.00
	Brake Line Set 6pc, Hardtop		
CHB6606	1966 Manual Drum	\$165.00	\$139.00
	Brake Line Set 6pc, Conv.		
CHB6607	1966 Power Drum	\$165.00	\$139.00
	Brake Line Set 6pc, Hardtop		
CHB6608	1966 Power Drum	\$165.00	\$139.00
	Brake Line Set 6pc, Conv.		

(Note: SS Cars had a front crossover that ran away from the exhaust manifold to keep heat from the brake line.)

## 1964-67 Chevelle\Malibu\SS

### Disc Brake Conversion Line Sets-Valve

CHB64D1	Power Disc Brake Line Set 9pc, Hardtop (Valve Mounted on Bracket at Master)	\$179.00	\$155.00
CHB64D3	Power Disc Brake Line Set 9pc, Convertible (Valve Mounted on Bracket at Master)	\$179.00	\$155.00



BRK-01	Prop. Valve Bracket, Aftermarket	\$18.00
VCH104	1964-67 Chevelle / El Camino Disc. Conv Valve	\$85.00

This valve upgrades the original brass block

(Note: This conversion is for modified cars with headers or exhaust clearance problems. Valve is mounted on a bracket at the master.)

### Disc Brake Conversion Line Sets-Stock

CHB64D6	Power Disc Brake Line Set 7pc, Hardtop (Block Mounted in Stock Location)	\$179.00	\$155.00
CHB64D7	Power Disc Brake 7pc Line Set, Convertible (Block Mounted in Stock Location)	\$179.00	\$155.00
CHB64D8	Manual Disc Brake Line Set 7pc, Hardtop (Block Mounted in Stock Location)	\$179.00	\$155.00
CHB64D9	Manual Disc Brake 7pc Line Set, Convertible (Block Mounted in Stock Location)	\$179.00	\$155.00
BLK102	64-67 A-Body (Dual Master Conversion Tee)	\$39.00	
BLK103	66 A-Body (Dual Master Conversion Tee)	\$39.00	

(Note: This conversion is for cars that want the stock look but are upgrading to dual master or disc brakes. For disc brake conversion the BLK102 & BLK103 must be used with an Adj. Prop Valve.)

CHB6707-Manual Drum  
Brake Line Set

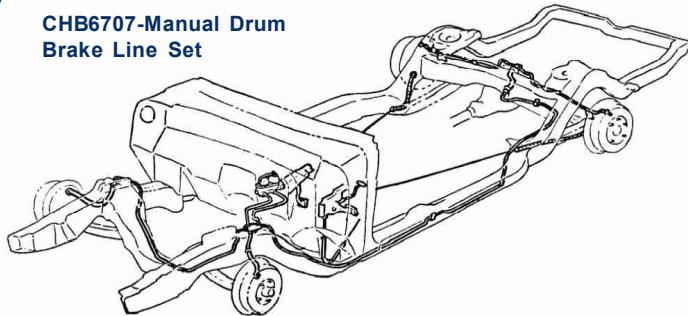

CHB65F1- Manual Drum  
Brake Line Set- SS ONLY

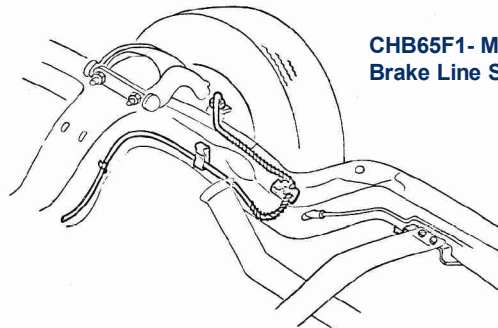

## Full Brake Line Sets 1967

	<u>1967 SS Model</u>	<u>Stainless</u>	<u>OE Steel</u>
CHB6701	1967 Manual Drum, <b>SS Only</b> Brake Line Set 7pc, Hardtop	\$175.00	\$145.00
CHB6702	1967 Manual Drum, <b>SS Only</b> Brake Line Set 7pc, Conv.	\$175.00	\$145.00
CHB6703	1967 Power Drum, <b>SS Only</b> Brake Line Set 7pc, Hardtop	\$175.00	\$145.00
CHB6704	1967 Power Drum, <b>SS Only</b> Brake Line Set 7pc, Conv.	\$175.00	\$145.00
CHB6705	1967 Power Disc, <b>SS Only</b> Brake Line Set 8pc, Hardtop	\$175.00	\$145.00
CHB6706	1967 Power Disc, <b>SS Only</b> Brake Line Set 8pc, Conv.	\$175.00	\$145.00
CHB6715	1967 Manual Disc, <b>SS Only</b> Brake Line Set 8pc, Hardtop	\$175.00	\$145.00
CHB6716	1967 Manual Disc, <b>SS Only</b> Brake Line Set 8pc, Conv.	\$175.00	\$145.00

(Note: SS Cars had a front crossover that ran away from the exhaust manifold to keep heat from the brake line)

	<u>1967 Non SS Model</u>	<u>Stainless</u>	<u>OE Steel</u>
CHB6707	1967 Manual Drum Brake Line Set 7pc, Hardtop	\$175.00	\$145.00
CHB6708	1967 Manual Drum Brake Line Set 7pc, Conv.	\$175.00	\$145.00
CHB6709	1967 Power Drum Brake Line Set 7pc, Hardtop	\$175.00	\$145.00
CHB6710	1967 Power Drum Brake Line Set 7pc, Conv.	\$175.00	\$145.00
CHB6711	1967 Power Disc Brake Line Set 7pc, Hardtop	\$175.00	\$145.00
CHB6712	1967 Power Disc Brake Line Set 8pc, Conv.	\$175.00	\$145.00
CHB6717	1967 Manual Disc Brake Line Set 8pc, Hardtop	\$175.00	\$145.00
CHB6718	1967 Manual Disc Brake Line Set 8pc, Conv.	\$175.00	\$145.00

### Rubber Flex Hoses

		<u>OEM</u>
CH-555	1964-67 Front Drum Hose	\$24.00
CH-005	1964-65 Rear Hose (Needs Tee GMTEE01)	\$24.00
CH-599	1967 Front Disc Hose	\$25.00
CH-553	1966-67 Rear Hose (Needs Tee GMTEE01)	\$25.00

## 1964-67 Chevelle\SS

### Front Brake Lines

		<u>Stainless</u>	<u>OE Steel</u>
CHB64F1	1964-65 Manual Drum Brake Line Set 3pc	\$80.00	\$60.00
CHB66F1	1966 Manual Drum Brake Line Set 3pc	\$80.00	\$60.00
CHB64F2	1964-66 Power Drum Brake Line Set 3pc	\$80.00	\$60.00
CHB65F1	1965-66 Manual Drum, <b>SS Only</b> Brake Line Set 3pc	\$80.00	\$60.00
CHB65F2	1965-66 Power Drum, <b>SS Only</b> Brake Line Set 3pc	\$80.00	\$60.00

(Note: SS Cars had a front crossover that ran away from the exhaust manifold to keep heat from the brake line)

CHB67F1	1967 Manual Drum Brake Line Set 4pc	\$90.00	\$65.00
CHB67F2	1967 Power Drum Brake Line Set 4pc	\$90.00	\$65.00
CHB67F3	1967 Manual Disc Brake Line Set 5pc	\$90.00	\$65.00
CHB67F4	1967 Power Disc Brake Line Set 5pc	\$90.00	\$65.00
CHB67F5	1967 Manual Drum, <b>SS Only</b> Brake Line Set 4pc	\$90.00	\$65.00
CHB67F6	1967 Power Drum, <b>SS Only</b> Brake Line Set 4pc	\$90.00	\$65.00
CHB67F7	1967 Manual Disc, <b>SS Only</b> Brake Line Set 5pc	\$90.00	\$65.00
CHB67F8	1967 Power Disc, <b>SS Only</b> Brake Line Set 5pc	\$90.00	\$65.00

(Note: SS Cars had a front crossover that ran away from the exhaust manifold to keep heat from the brake line)

CHB67F9	67 Dual Piston Caliper Lines 1/2" Fitting on Left & 7/16 on Right Caliper Side	\$25.00	\$20.00
CHB67F10	67 Dual Piston Caliper Lines 1/2" 3/8" Fitting on Left & 3/8" on Right Caliper Side	\$25.00	\$20.00

### Front To Rear Brake Lines

CHB64M1	1964 Hardtop 1pc	\$65.00	\$55.00
CHB64M2	1964 Convertible 1pc	\$65.00	\$55.00
CHB65M1	1965 Hardtop 1pc	\$65.00	\$55.00
CHB65M2	1965 Convertible 1pc	\$65.00	\$55.00
CHB66M1	1966 Hardtop 1pc	\$65.00	\$55.00
CHB66M2	1966 Convertible 1pc	\$65.00	\$55.00
CHB67M1	1967 Hardtop 1pc	\$65.00	\$55.00
CHB67M2	1967 Convertible 1pc	\$65.00	\$55.00

### Axle Brake Lines

CHB64R1	1964-66 All Cars 2pc	\$35.00	\$25.00
CHB67R1	1967 All Cars 2pc	\$35.00	\$25.00

CHF6402 Fuel Line Hdt

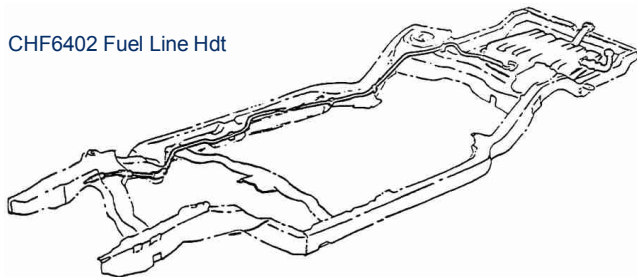

**64-67 Fuel Lines-Hardtop** Stainless OE Steel

CHF6408	Main Fuel Line 1pc 3/8" <b>HDT</b> Round Bend at Rear <b>SS only</b>	\$99.00	\$65.00
CHF6401	Main Fuel Line 1pc 5/16" <b>HDT</b> Square Bend at Rear	\$99.00	\$65.00
CHF6402	Main Fuel Line 1pc 3/8" <b>HDT</b> Square Bend at Rear	\$99.00	\$65.00
CHF6405	Fuel Return Line 1pc 1/4" <b>HDT</b> Square Bend at Rear	\$99.00	\$65.00

**64-67 Fuel Lines-Convertible**

CHF6404	Main Fuel Line 1pc 3/8" <b>Conv.</b> Round Bend at Rear <b>SS only</b>	\$99.00	\$65.00
CHF6409	Main Fuel Line 1pc 5/16" <b>Conv.</b> Square Bend at Rear	\$99.00	\$65.00
CHF6410	Main Fuel Line 1pc 3/8" <b>Conv.</b> Square Bend at Rear	\$99.00	\$65.00
CHF6406	Fuel Return Line 1pc 1/4" <b>Conv.</b> Square Bend at Rear	\$99.00	\$65.00

**64-67 Custom Made Fuel Lines**

CHF6411	Main Fuel Line 1pc 7/16" <b>HDT</b> Square Bend at Rear	\$130.00	N/A
CHF6412	Main Fuel Line 1pc 1/2" <b>HDT</b> Square Bend at Rear	\$130.00	N/A
CHF6413	Fuel Return Line 1pc 5/16" <b>HDT</b> Square Bend at Rear	\$99.00	N/A
CHF6414	Main Fuel Line 1pc 7/16" <b>Conv.</b> Square Bend at Rear	\$130.00	N/A
CHF6415	Main Fuel Line 1pc 1/2" <b>Conv.</b> Square Bend at Rear	\$130.00	N/A
CHF6416	Fuel Return Line 1pc 5/16" <b>Conv.</b> Square Bend at Rear	\$99.00	N/A

**Trunk Lines**

CHF6707	64-67 Trunk Vent Tube	\$39.00	\$29.00
---------	-----------------------	---------	---------

**Rubber Fuel Line Sets**



**Rubber Fuel Lines**

FHS-301	3/8" (2') hose with 4 correct color clips Used for both ends of main fuel line	\$4.50
FHS-302	5/16" (2') hose with 4 correct color clips Used for main fuel line or Vapor Line	\$4.50
FHS-303	1/4" (2') hose with 4 correct color clips Used for Fuel Return Line	\$4.50

CHT6401 1964-65 Trans Cooler Lines

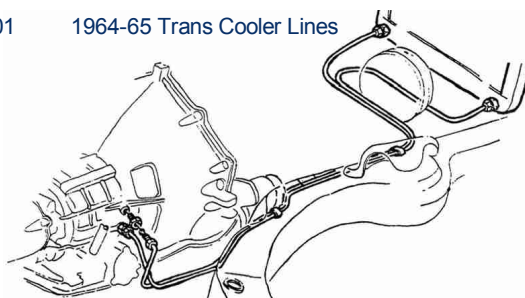

**Transmission Lines**

	<u>Stainless</u>	<u>OE Steel</u>
CHT6401	1964-65 Trans Cooler Lines Power Glide, 2pc set, 5/16, Small Block	\$75.00 \$45.00
CHT6601	1966-67 Trans Cooler Lines Power Glide, 2pc set, 5/16, Small Block	\$75.00 \$45.00
CHT6501	1965-67 Trans Cooler Lines Power Glide, 2pc set, 5/16, Big Block	\$75.00 \$45.00
CHT6702	1966-67 Trans Cooler Lines T-400, 2pc set, 5/16, Big Block	\$75.00 \$45.00

CHT6404  
65-66 Trans Mod Line  
Power Glide

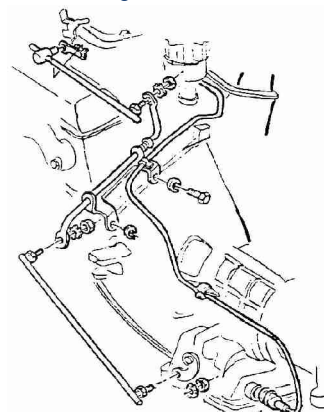

**Transmission Modulator Lines**

CHT6403	64 Trans Mod Line Power Glide 283 cid, V8, 4bbl	\$35.00	\$25.00
CHT6404	65 Trans Mod Line Power Glide V8, All small block engines	\$35.00	\$25.00
CHT6405	66 Trans Mod Line Power Glide with 396 cid engine	\$35.00	\$25.00
CHT6406	67 Trans Mod Line T-400 with 396 cid engine	\$35.00	\$25.00
CHT6407	66-67 Trans Mod Line Power Glide V8, All small block engines	\$35.00	\$25.00
CHT6408	64-67 Trans Mod Line Power Glide All 6 Cylinder engines	\$35.00	\$25.00



**Inline Tube's disc brake conversions upgrade your drum brake car to discs. You have been pushing on a brake pedal that feels like a brick too long, upgrade today.**

## 283 cid Engine Pump To Carb Lines

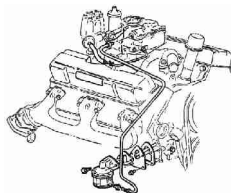

CHE6401

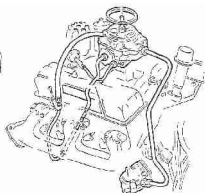

CHE6402

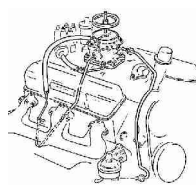

CHE6602

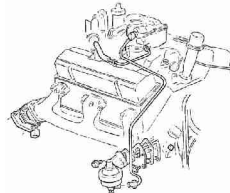

CHE6703

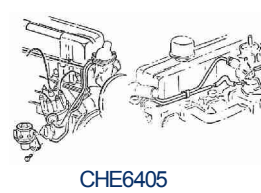

CHE6405  
CHE6608

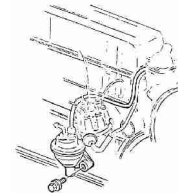

CHE6707

## 327 cid Engine Pump To Carb Lines

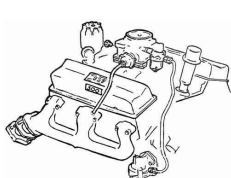

CHE6603  
CHE6403

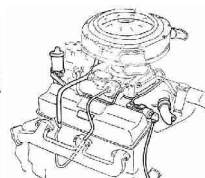

CHE6604  
CHE6404

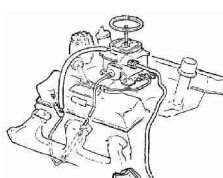

CHE6406

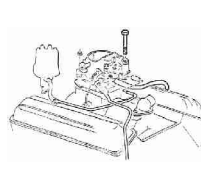

CHE6704

## 396 Big Block Engine Pump To Carb Lines

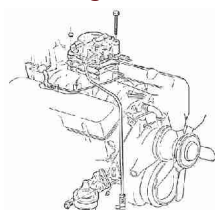

CHE6605

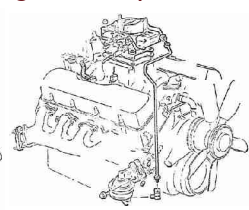

CHE6606

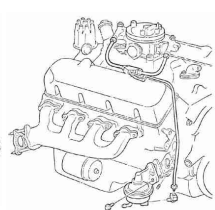

CHE6607

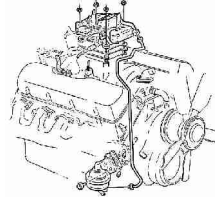

CHE6708

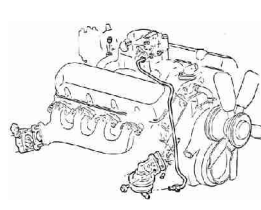

CHE6802

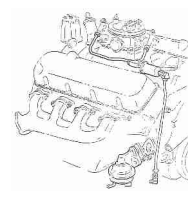

CHE6510

	<u>Engine Lines</u>	<u>Stainless</u>	<u>OE Steel</u>
CHE6401	64-65 Pump to Carb Line 283 cid 195 H.P. 2bbl Carb	\$25.00	\$20.00
CHE6402	64-65 Pump to Carb Line 283 cid 220 H.P. 4bbl Carb	\$25.00	\$20.00
CHE6403	64-65 Pump to Carb Line 327 cid 4bbl, Glass Filter at Carb L-74 300 H.P.	\$25.00	\$20.00
CHE6404	64-65 Pump to Carb Line (Disc). 327 cid 350 H.P. 4bbl 2 pc w/Holley Single Feed Carb L-79 & L-76	\$25.00	\$20.00
CHE6405	64-66 Pump Carb Line 194 cid 6cyl	\$25.00	\$20.00
CHE6406	64-65 Pump to Carb Line 327 Cid 250 HP, 4bbl No Glass Filter	\$25.00	\$20.00
CHE6407	64 Pump to Carb 250Cid, 6cyl With AC	\$25.00	\$20.00
CHE6510	65 Pump to Carb Line 396 cid 325-425 H.P. 4bbl L-37 w/holley duel Feed with filter 3pc set I-37	\$38.00	\$27.00
CHE6602	66 Pump to Carb Line 283 cid 195 H.P. 4bbl L-77	\$25.00	\$20.00
CHE6603	66 Pump to Carb Line 327 cid 275/300 H.P. 4bbl	\$25.00	\$20.00
CHE6604	66 Pump to Carb Line 327 cid 350 H.P. 4bbl	\$25.00	\$20.00
CHE6605	66 Pump to Carb Line 396 cid 325 HP w/Roch 4bbl, 1pc L-35	\$25.00	\$20.00
CHE6606	66 Pump to Carb Line 396 cid 325 HP 4bbl w/Holley Single Feed L-34	\$25.00	\$20.00
CHE6607	66 Pump to Carb Line 396 cid 4bbl 360/375 H.P. L-78, 3pc w/Y Block	\$38.00	\$27.00

	<u>Engine Lines - Continued</u>	<u>Stainless</u>	<u>OE Steel</u>
CHE6608	66 Pump to Carb Line 230 cid 140 H.P. 6 cyl.	\$25.00	\$20.00
CHE6703	67 Pump to Carb Line 283 cid 195 H.P.	\$25.00	\$20.00
CHE6704	67-68 Pump to Carb Line 327 cid 275 H.P. 4bbl 5/16"	\$25.00	\$20.00
CHE6707	67 Pump to Carb Line 230/250 cid 6cyl Front Inlet Carb	\$25.00	\$20.00
CHE6708	67 Pump to Carb Line 396 cid 350 H.P. 4bbl w/Holley Single Line	\$25.00	\$20.00
CHE6802	67 Pump to Carb Line 396 cid 325 H.P. 4bbl Roch Carb 1pc	\$25.00	\$20.00
CHE6809	67 Pump to Carb Line 327 cid 325 H.P. 4bbl 1pc 3/8" w/Holley Single Feed	\$25.00	\$20.00
	<u>Engine Vacuum Lines</u>		
CHV6701	67-70 Engine Vacuum Line all Small Block V-8 4bbl	\$25.00	\$20.00
CHV6702	67-69 Engine Vacuum Line all Small Block V-8 2bbl	\$25.00	\$20.00
CHV6703	67-69 Engine Vacuum Line all Big Block 4bbl Roch, Carb	\$25.00	\$20.00
CHV6801	68-72 Engine Vacuum Line all Big Block 4bbl Holley, Carb	\$25.00	\$20.00
	<u>Misc Lines</u>		
CHM6401	64-65 Factory Air Shock Lines 3pc	\$25.00	\$20.00
	<u>Power Steering Return Lines</u>		
CHS6801	68-72 Power Steering Return Line	\$16.00	\$10.00