

1970 Pontiac Firebird/TA

Full Brake Line Sets

		<u>Stainless</u>	<u>OE Steel</u>
PFB7001	Power Disc Brake Line Set 1970 only, 10pc Set	\$185.00	\$160.00
PFB7002	Manual Disc Brake Line Set 1970 only, 10pc Set	\$185.00	\$160.00

Rubber Flex Hoses

		<u>OEM</u>
H-672	1969-70 Front Disc Hose	\$25.00ea

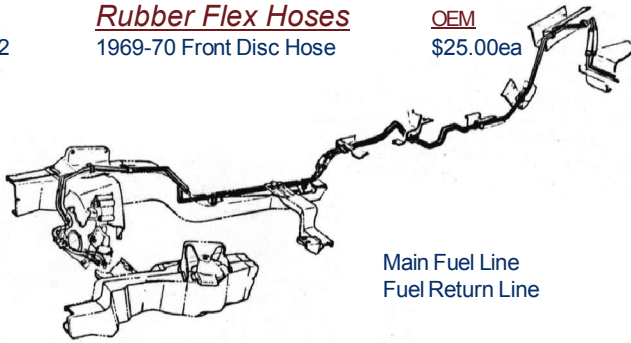

Main Fuel Lines

PFF7001	1970-71 Fuel Line Tank to Pump 2pc, 3/8" Pass Side Routing	\$99.00	\$69.00
PFF7003	1970-71 Fuel Return Line Tank to Pump 1/4" PS Routing	\$99.00	\$69.00

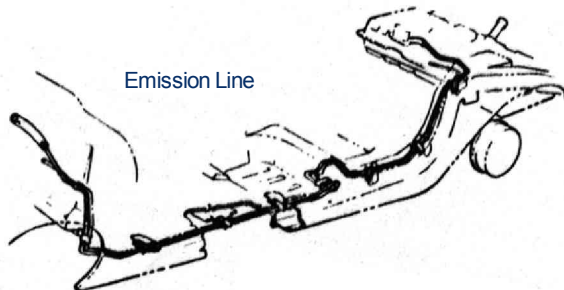

Fuel Emission Lines

PFF7004	1970 Main Vapor Line 1pc DS Routing, Calif Cars Only	\$99.00	\$69.00
---------	---	---------	---------



PFF7005	1970 Vapor Lines 3pc, Calif Only	\$39.00	\$29.00
---------	----------------------------------	---------	---------

Transmission Lines

PFT7001	1970-72 Trans Cooler Lines Turbo 350, 2pc, 5/16"	\$75.00	\$50.00
PFT7002	1970-72 Trans Cooler Lines Turbo 400, 2pc, 5/16"	\$75.00	\$50.00
PFT7003	1970-72 Trans Mod Line T-400	\$35.00	\$25.00
PFT7004	1970-72 Trans Mod Line T-350	\$35.00	\$25.00

1970 Pontiac Firebird/TA

Engine Lines

		<u>Stainless</u>	<u>OE Steel</u>
PFE7001	1970 2bbl V8	\$25.00	\$20.00
PFE7002	1970 4bbl V8, all & Ram Air III Bottom Outlet Pump Passes Passenger Side of Thermostat Housing	\$25.00	\$20.00
PFE7003	1970 4bbl V8, Ram Air IV Bottom Outlet Pump Passes Driver Side of Thermostat Housing	\$25.00	\$20.00

1971 Pontiac Firebird/TA

71-73 Full Brake Line Set



Full Brake Line Sets

		<u>Stainless</u>	<u>OE Steel</u>
PFB7101	Power Disc Brake Line Set 1971-73, 7pc Set	\$175.00	\$150.00
PFB7102	Manual Disc Brake Line Set 1971-73, 7pc Set	\$175.00	\$150.00

Main Fuel Lines

PFF7101	1970-71 Fuel Line Tank to Pump 2pc, 3/8" Pass Side Routing	\$99.00	\$69.00
PFF7103	1970-71 Fuel Return Line Tank to Pump 1/4" PS Routing	\$99.00	\$69.00

Fuel Emission Lines

PFF7106	1971-74 Vapor Line 1pc Core Support, 5/16" dia	\$35.00	\$25.00
PFF7104	1971-73 Main Vapor Line 1pc DS Routing	\$99.00	\$69.00
PFF7105	1971-73 Vapor Tank Lines 3pc	\$39.00	\$29.00

Transmission Lines

PFT7101	1971 Trans Cooler Lines 2pc, Turbo 350 / 400, 5/16" - with 5/8-18 Red Fittings @ Rad	\$75.00	\$50.00
PFT7102	1970-72 Trans Cooler Lines 2pc Turbo 350/400, 5/16" - with 1/2-20 Std. Fitting @ Rad	\$75.00	\$50.00
PFT7103	1970-72 Trans Mod Line T-400	\$35.00	\$25.00
PFT7104	1970-72 Trans Mod Line T-350	\$35.00	\$25.00

Engine Lines

PFE7101	1971 4bbl 455 cid Pump to Carb	\$25.00	\$20.00
PFE7102	1971 4bbl 400 cid Pump to Carb	\$25.00	\$20.00

Quick Tip: Fluid

DOT 3 originally came in the brake system. This fluid can destroy your paint and collects moisture which over time reduces performance. Under extreme braking conditions (constant drag racing) or excessive braking, Dot 3 will out perform DOT 5 (silicone fluid). DOT 5 is an excellent choice for museum cars since it will not collect moisture and does not harm paint. Never mix DOT 5 & DOT 3 fluids.



Clip Sets are Available for
Pontiac Cars Pg 222

1972-73 Pontiac Firebird/TA

71-73 Full Brake Line Set

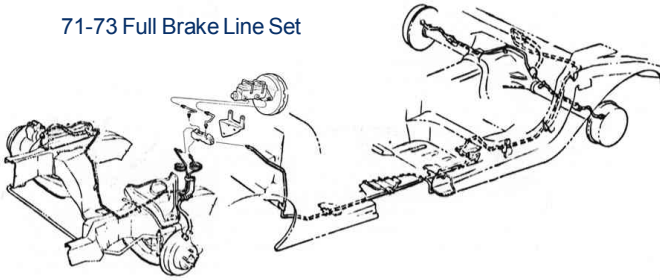

	<u>Full Brake Line Sets</u>	<u>Stainless</u>	<u>OE Steel</u>
PFB7201	Power Disc Brake Line Set 1971-73, 7pc Set	\$175.00	\$150.00
PFB7202	Manual Disc Brake Line Set 1971-73, 7pc Set	\$175.00	\$150.00

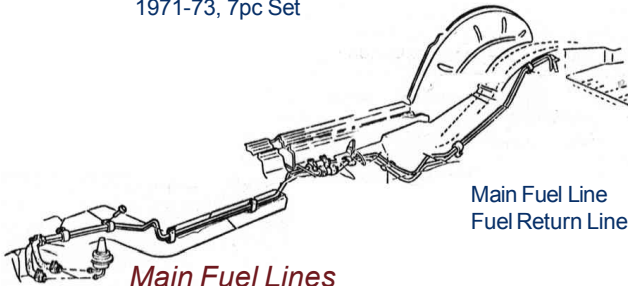

Main Fuel Line
Fuel Return Line

	<u>Main Fuel Lines</u>		
PFF7201	1972-74 Fuel Line Tank to Pump 2pc, 3/8" Pass Side Routing	\$99.00	\$69.00
PFF7203	1972-74 Fuel Return Line Tank to Pump 1/4" PS Routing	\$99.00	\$69.00

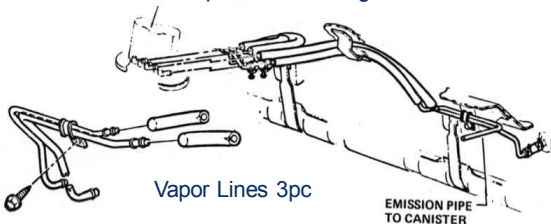

Vapor Lines 3pc

EMISSION PIPE
TO CANISTER

	<u>Fuel Emission Lines</u>		
PFF7206	1972-74 Vapor Line 1pc Core Support, 5/16" dia	\$35.00	\$25.00
PFF7204	1972-73 Main Vapor Line 1pc DS Routing	\$99.00	\$69.00
PFF7205	1971-73 Vapor Lines 3pc	\$39.00	\$29.00
	<u>Transmission Lines</u>		
PFT7201	1970-72 Trans Cooler Lines Turbo 350, 2pc, 5/16"	\$75.00	\$50.00
PFT7202	1970-72 Trans Cooler Lines Turbo 400, 2pc, 5/16"	\$75.00	\$50.00
PFT7301	1973 Trans Cooler Lines Turbo 400/ 350, 2pc, 5/16"	\$75.00	\$50.00
PFT7203	1972-73 Trans Mod Line T-400	\$35.00	\$25.00
PFT7204	1972-73 Trans Mod Line T-350	\$35.00	\$25.00
	<u>Engine Lines</u>		
PFE7201	1972 Pump to Carb 400/ 455 4bbl	\$25.00	\$20.00
PFE7301	1973-74 Pump to Carb 400 4bbl	\$25.00	\$20.00
PFE7302	1973-74 Pump to Carb 455 4bbl	\$25.00	\$20.00

1974 Pontiac Firebird/TA

74-75 Full Brake Line Set

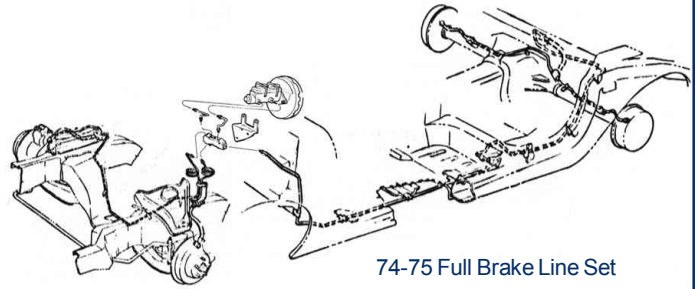

	<u>Full Brake Line Sets</u>	<u>Stainless</u>	<u>OE Steel</u>
PFB7401	Power Disc Brake Line Set 1974-75, 7pc Set	\$175.00	\$150.00
PFB7402	Manual Disc Brake Line Set 1974-75, 7pc Set	\$175.00	\$150.00

Photo Opposite Side of Page

	<u>Main Fuel Lines</u>		
PFF7401	1972-74 Fuel Line Tank to Pump 2pc, 3/8" Pass Side Routing	\$99.00	\$69.00
PFF7403	1972-74 Fuel Return Line Tank to Pump 1/4" PS Routing	\$99.00	\$69.00

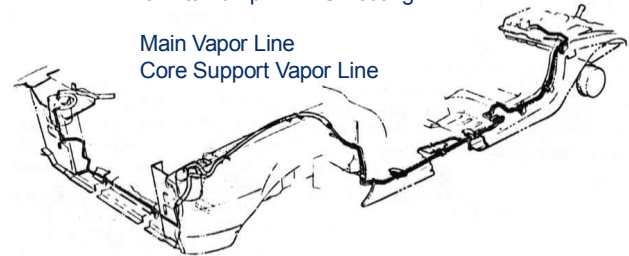

Main Vapor Line
Core Support Vapor Line

	<u>Fuel Emission Lines</u>		
PFF7406	1972-74 Vapor Line 1pc Core Support, 5/16" dia	\$35.00	\$25.00
PFF7404	1974 Main Vapor Line 1pc DS Routing	\$99.00	\$69.00
	<u>Transmission Lines</u>		
PFT7401	1974-75 Trans Cooler Lines Turbo 350, 2pc, 5/16"	\$75.00	\$50.00
PFT7402	1974-75 Trans Cooler Lines Turbo 400, 2pc, 5/16"	\$75.00	\$50.00
PFT7403	1974-75 Trans Mod Line T-400	\$35.00	\$25.00
PFT7404	1974-75 Trans Mod Line T-350	\$35.00	\$25.00
	<u>Engine Lines</u>		
PFE7301	1973-74 Pump to Carb 400 4bbl	\$25.00	\$20.00
PFE7302	1973-74 Pump to Carb 455 4bbl	\$25.00	\$20.00



Our attention to detail has made us the best in the industry. Our restoration projects allow us to pass our technical knowledge on to you.

1975 Pontiac Formula /TA

Full Brake Line Sets

		<u>Stainless</u>	<u>OE Steel</u>
PFB7501	Power Disc Brake Line Set 1974-75, 7pc Set	\$179.00	\$155.00
PFB7502	Manual Disc Brake Line Set 1974-75, 7pc Set	\$179.00	\$155.00

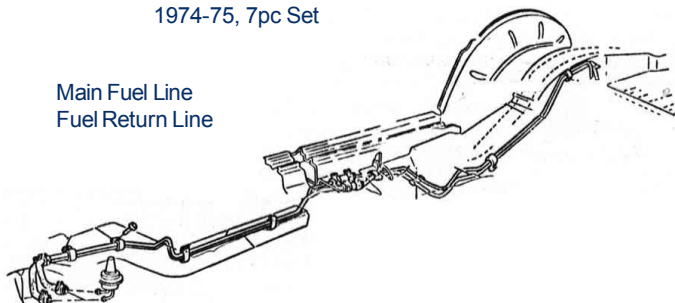

Main Fuel Lines

PFF7501	1975-79 Fuel Line Tank to Pump 2pc, 3/8" Driver Side Routing	\$99.00	\$69.00
PFF7502	1975-79 Fuel Return Line Tank to Pump 1/4" PS Routing	\$99.00	\$69.00

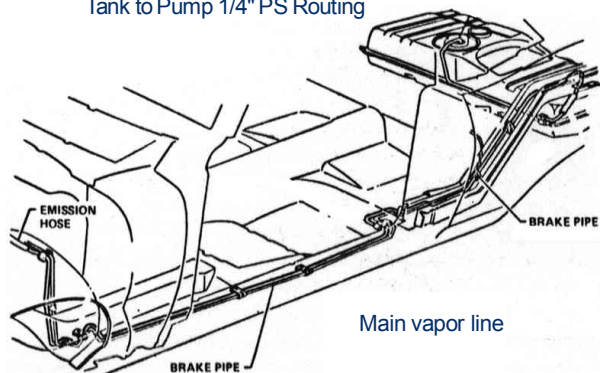

Fuel Emission Lines

PFF7503	1975-79 Vapor Lines 2pc Passenger Side Routing	\$99.00	\$69.00
---------	---	---------	---------

Transmission Lines

PFT7501	1974-75 Trans Cooler Lines Turbo 350, 2pc, 5/16"	\$75.00	\$50.00
PFT7502	1974-75 Trans Cooler Lines Turbo 400, 2pc, 5/16"	\$75.00	\$50.00
PFT7503	1975-79 Trans Modulator Line Pontiac 400	\$35.00	\$25.00

Engine Lines

PFE7501	1975 Pump to Carb 400 4bbl	\$25.00	\$20.00
PFE7502	1975 Pump to Carb 455 4bbl	\$25.00	\$20.00
PFE7503	1975 Pump to Carb 350 4bbl	\$25.00	\$20.00



Stainless Brake Cables Page 187

When ordering **Stainless Steel Lines**
Please place a "S" in front of the part number.

1976-79 Pontiac Formula /TA

76-79 Full Brake Line Set

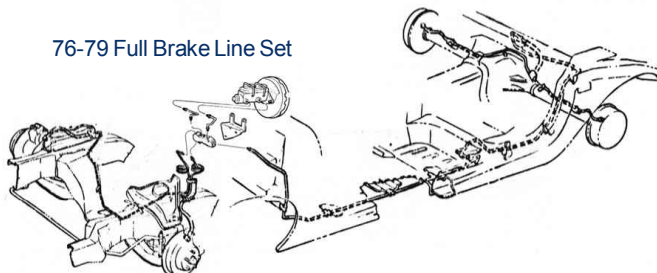

Full Brake Line Sets

		<u>Stainless</u>	<u>OE Steel</u>
PFB7601	Power Disc Brake Line Set 1976-80, 7pc Set	\$179.00	\$155.00
PFB7602	4 Wheel Disc Brake Line Set 1979-80, 7pc Set	\$179.00	\$155.00

Main Fuel Lines

PFF7601	1975-79 Fuel Line Tank to Pump 2pc, 3/8", 403 Olds cid, DS Routing, PS Fuel Pump	\$99.00	\$69.00
PFF7603	1975-79 Fuel Line Tank to Pump 2pc, 3/8", Pont V8, 400 cid, DS Routing, DS Fuel Pump	\$99.00	\$69.00
PFF7606	1975-79 Fuel Return Line, 2pc, 1/4"	\$99.00	\$69.00
PFF7607	Tank to Pump, 403 Olds cid, PS Routing, PS Fuel Pump 1975-79 Fuel Return Line, 2 pc 1/4"	\$99.00	\$69.00
PFF7607	Tank to Pump, Pont V8, 400 cid, PS Rout, DS Fuel Pump	\$99.00	\$69.00

Fuel Emission Lines

PFF7604	1975-79 Vapor Lines 2pc 403 Olds cid, PS Routing	\$99.00	\$69.00
PFF7608	1975-79 Vapor Lines 2pc Pont V8, 400 cid, PS Routing	\$99.00	\$69.00
PFF7701	1977-78 Vapor Tank Lines 3pc Trans Am	\$95.00	\$85.00

Transmission Lines

PFT7601	1976-81 Trans Cooler Lines Turbo 350, 2pc, 5/16"	\$75.00	\$50.00
PFT7602	1976-81 Trans Cooler Lines Turbo 400, 2pc, 5/16"	\$75.00	\$50.00
PFT7603	1975-78 Trans Modulator Line Pontiac 400	\$35.00	\$25.00
PFT7604	1979-81 Trans Modulator Line Oldsmobile 403	\$35.00	\$25.00

Engine Lines

PFE7601	1976 Pump to Carb 4bbl 400	\$33.00	\$28.00
PFE7702	1977-79 Pump to Carb 4bbl 400 With Black Insulation	\$33.00	\$28.00
PFE7701	1977-78 Booster Vacuum Line Pontiac 400 Eng	\$14.00	\$12.00
PFE7703	1977-78 Carb to Vacuum Canister Pont Eng 4bbl 400	\$25.00	\$20.00
PFE7704	1979 Carb to Exhaust Manifold Pont Eng 4bbl 400	\$16.00	\$12.00

Engine Lines - Olds 403 cid 4bbl

PFE7902	1977-79 Pump to Carb 4bbl 403	\$25.00	\$20.00
PFE7903	1977-79 Choke Tubes 4bbl 403	\$24.00	\$20.00
PFE7901	1978-79 Booster Vac Line 403	\$14.00	\$12.00
PFE7905	1977 Booster Vac Line 403	\$14.00	\$12.00
PFE7904	1977-79 Oil Press Line 4bbl 403	\$11.00	\$9.00

State: Pontiac or Olds Engine & Long Fuel Pump or Short Fuel Pump

1980-81 Pontiac Firebird/TA

80-81 Full Brake Line Set

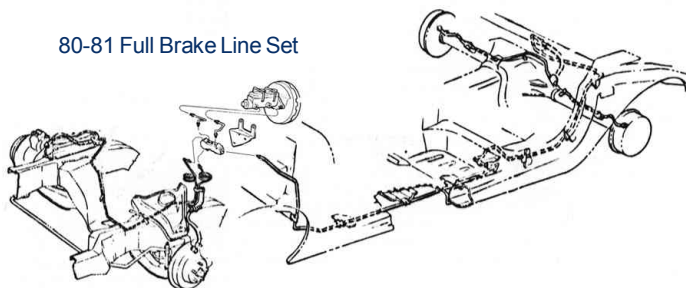

Full Brake Line Sets

		<u>Stainless</u>	<u>OE Steel</u>
PFB8001	Power Disc Brake Line Set 1976-80, 7pc Set	\$179.00	\$155.00
PFB8002	4 Wheel Disc Brake Line Set 1979-80, 7pc Set	\$179.00	\$155.00
PFB8101	Power Disc Brake Line Set 1981, 7pc Set	\$179.00	\$155.00
PFB8102	4 Wheel Disc Brake Line Set 1981, 7pc Set	\$179.00	\$155.00

Main Fuel Lines

PFF8001	1980-81 Fuel Line Tank to Pump 2pc, 3/8" Driver Side Routing	\$99.00	\$69.00
PFF8003	1980-81 Fuel Return Line Tank to Pump 2pc, 1/4" Passenger Side Routing	\$99.00	\$69.00

Fuel Emission Lines

PFF8004	1980-81 Vapor Lines 2pc, 5/16" Passenger Side Routing	\$99.00	\$69.00
---------	--	---------	---------

Transmission Lines

PFT8001	80-81 Trans Cooler Lines T-350 / T-400 2pc, 5/16"	\$75.00	\$50.00
PFT8002	80-81 Turbo Trans Cooler Lines T-350 2pc, 5/16"	\$75.00	\$50.00
PFT8004	80-81 Trans Mod Line 301Cid	\$35.00	\$25.00
PFT8005	80-81 Turbo TA, Pont 301 Cid Trans Modulator Line 2pc	\$40.00	\$30.00

Engine Lines

PFE8009	1980-81 Pont 301 Cid, 140 hp Pump to Carb Line, 1pc	\$30.00	\$25.00
PFE8010	1980-81 Pont 305 Cid, 150 hp Pump to Carb Line, 1pc	\$25.00	\$20.00
PFE8005	1980 Turbo TA, Pont 301 Cid Pump To Carb Line, 1 pc	\$30.00	\$25.00
PFE8006	1980 Turbo TA, Pont 301 Cid Engine Vacuum Line, 1pc	\$14.00	\$12.00
PFE8007	1980 Turbo TA, Pont 301 Cid Oil Pressure Line, 1pc	\$20.00	\$16.00
PFE8008	1980 Turbo TA, Pont 301 Cid Carb to EMS Vacuum Can, 1pc	\$25.00	\$20.00
PFE8101	1981 Turbo TA, Pont 301 Cid Pump To Carb Line, 1 pc	\$30.00	\$25.00
PFE8103	1981 Turbo TA, Pont 301 Cid Oil Pressure Line, 1pc	\$20.00	\$16.00
PFE8104	1981 Turbo TA, Pont 301 Cid Carb to EMS Vacuum Can, 1pc	\$25.00	\$20.00

When ordering **Stainless Steel Lines**
Please place a "S" in front of the part number.



1982-92 Pontiac FirebirdTA

Full Brake Line Sets

		<u>Stainless</u>	<u>OE Steel</u>
PFB8201	Power Disc Brake Line Set 1982-83, 7pc Set Standard Fittings	\$185.00	\$165.00
PFB8202	4 Wheel Disc Brake Line Set 1982-83, 7pc Set Standard Fittings	\$185.00	\$165.00
PFB8203	Power Disc Brake Line Set 1984-92, 7pc Set Metric Fittings	\$185.00	\$165.00
PFB8204	4 Wheel Disc Brake Line Set 1984-92, 7pc Set Metric Fittings	\$185.00	\$165.00

Fuel Lines - Carbureted

PFF8201	1982-86 Main Fuel Line V8 Tank to Pump 1pc, 3/8" Pass Side Routing, Carbureted	\$99.00	\$69.00
PFF8203	1982-86 Fuel Return Line V8 Tank to Pump 1pc, 5/16" Pass Side Routing, Carbureted	\$99.00	\$69.00
PFF8204	1982-86 Vapor Lines V8 Tank to Pump 1pc, 1/4" DS Side Routing, Carbureted	\$99.00	\$69.00

Fuel Lines - Fuel Injected

PFF8501	1985-87 Main Fuel Line V8 Tank to Pump 1pc, 3/8" Drivers Side Routing, Fuel Injected	\$99.00	\$69.00
PFF8502	1985-87 Fuel Return Line V8 Tank to Pump 1pc, 5/16" Drivers Side Routing, Fuel Injected	\$99.00	\$69.00
PFF8503	1985-87 Vapor Lines V8 Tank to Pump 1pc, 1/4" PS Side Routing, Fuel Injected	\$99.00	\$69.00
PFF8801	1988-92 Main Fuel Line V8 Tank to Pump 1pc, 3/8" Drivers Side Routing, Fuel Injected	\$99.00	\$69.00
PFF8802	1988-92 Fuel Return Line V8 Tank to Pump 1pc, 5/16" Drivers Side Routing, Fuel Injected	\$99.00	\$69.00
PFF8803	1988-92 Vapor Lines V8 Tank to Pump 1pc, 1/4" PS Side Routing, Fuel Injected	\$99.00	\$69.00
PFF8804	1988-92 Vapor Lines V8 Tank to Canister 1pc, 1/4" DS Side Routing, Fuel Injected	\$99.00	\$69.00

Transmission Lines

PFT8201	1982-86 Trans Cooler Lines 700R4, 2pc, 5/16"	\$75.00	\$50.00
PFT8202	1982-86 Trans Cooler Lines T-350, 2pc, 5/16"	\$75.00	\$50.00

Engine Lines

PFE8501	1985 TA Pump To Carb Line 305 CID, 4bbl Standard Engine	\$35.00	\$25.00
---------	--	---------	---------

1971-81 Proportioning Valve

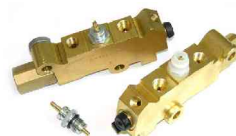

VPL113 1971-81 Firebird Trans Am Disc/ Drum Prop. Valve \$85.00